

## Technical Specifications / Engineering Submittals

Raritan Model Number: PX3-5500A1V

rev20180528

### LINE DRAWING

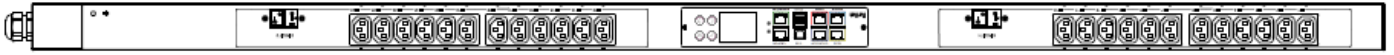

### FEATURES

Energy Metering	Voltage (V), Current (A), Active Power (kW), Real Power (kVA), Energy (kWh), Power Factor
Metering Accuracy	ISO/IEC 62053-21 1%
Metering per Input Line	Yes
Metering per Branch Circuit Breaker	Yes
Metering per Output Receptacle	Yes
Remote Outlet Switching	Yes
Environmental Sensor Ready	Yes
Replaceable Controller	Yes
Compatible Sensors	Temperature, Humidity, Air Flow, Differential Pressure, Water Leak, and Contact Closure
Networking	Gigabit (10/100/1000 BaseT) Ethernet port; secondary, redundant (10/100 BaseT) Ethernet port. Optional WiFi (802.11a/b/g/n)
Remote Management	HTTP(s); SSH; Telnet; RS-232 (Serial); Power IQ; SNMP version v2/v3; SMTP; JSON-RPC; Modbus over TCP
Cascading	Yes, Max 16 PDUs can be daisy chained using a single Ethernet or USB connection
Onboard Display	Color, matrix LCD display : Voltage, current, or active power (per line, per breaker, or per receptacle / outlet); Alarms; Configuration information (name, ratings, IP / Networking information); Auto-flip orientation
Embedded Processor	ARM Cortex A5 536MHZ (Atmel A5D35A), 16MB SPI Flash, 64MB DDR2 RAM

## Technical Specifications / Engineering Submittals

Raritan Model Number: PX3-5500A1V

rev20180528

### INPUT

Input Plug	Clipsal 56P332 (2P3W)
Cord Length	3 meters (9.84 feet) standard
Cord Entry	Bottom-bottom feed
Cable Type	IP66
Number of Power Cords	1
Maximum Input Current	32A
Nominal Input Voltage	240V
Rated Input Voltage	240 - 240V
Input Frequency	50/60Hz
Power Capacity	7.7kVA at 240V, 7.7kVA at 240V

### OUTPUT

Nominal Output Voltage	240V
Rated Output Voltage	240 - 240V
Receptacles (Output Connections)	(24) IEC320 C13, 10A
Securelock Support	Yes
Cord Retention	Yes
Overload Protection	(2) LEGBXA6-16

### PHYSICAL

Color	Black powder coat (custom colors available)
Unit Dimensions (WxDxH)	2.1" x 2.6" x 60.6" ; 52mm x 65mm x 1539mm
Unit Weight	5.7 kg
Shipping Weight	8.2 kg
Shipping Dimensions (WxDxH)	11.02" x 4.53" x 71.46" ; 280mm x 115mm x 1815mm
Mounting	G2-RACK-FOR-ZU

## Technical Specifications / Engineering Submittals

Raritan Model Number: PX3-5500A1V

rev20180528

### ENVIRONMENTAL

---

Operating Temperature 60°C

---

Operating Relative Humidity 85%

---

Operating Elevation 0-10000ft

---

### CONFORMANCE

---

Regulatory Approvals CE, Canada ICES-003, Part 15 Class A of the FCC rules,  
RoHS compliant

---

Warranty Standard 2 years manufacturer warranty

---

## Technical Specifications / Engineering Submittals

Raritan Model Number: PX3-5500A1V

rev20180528

### CONTROL PANEL



# Technical Specifications / Engineering Submittals

Raritan Model Number: PX3-5500A1V

rev20180528

## ELECTRICAL (ONE LINE) DIAGRAM

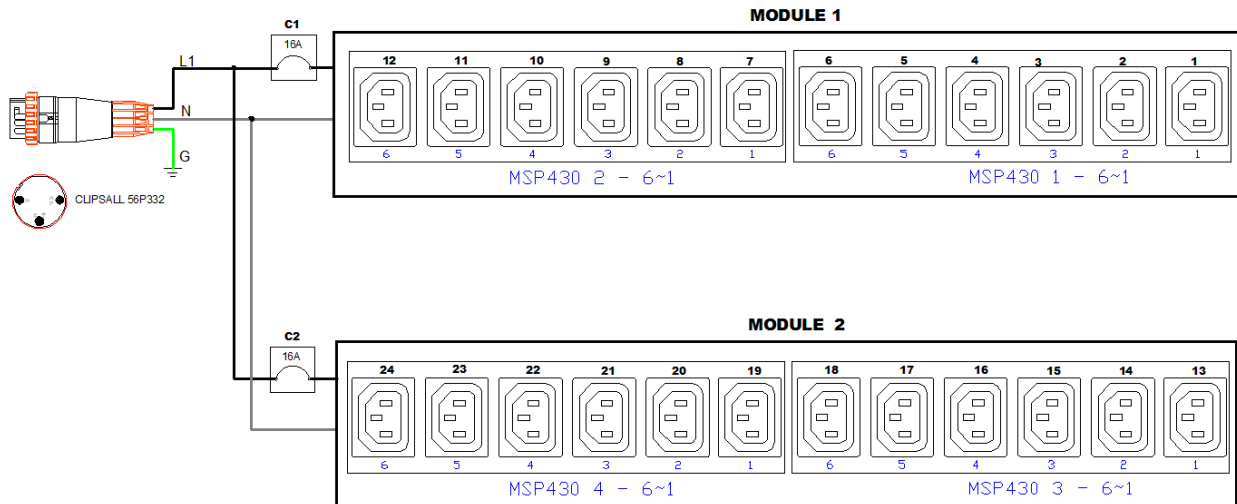

# Technical Specifications / Engineering Submittals

Raritan Model Number: PX3-5500A1V

rev20180528

## MECHANICAL DIAGRAM

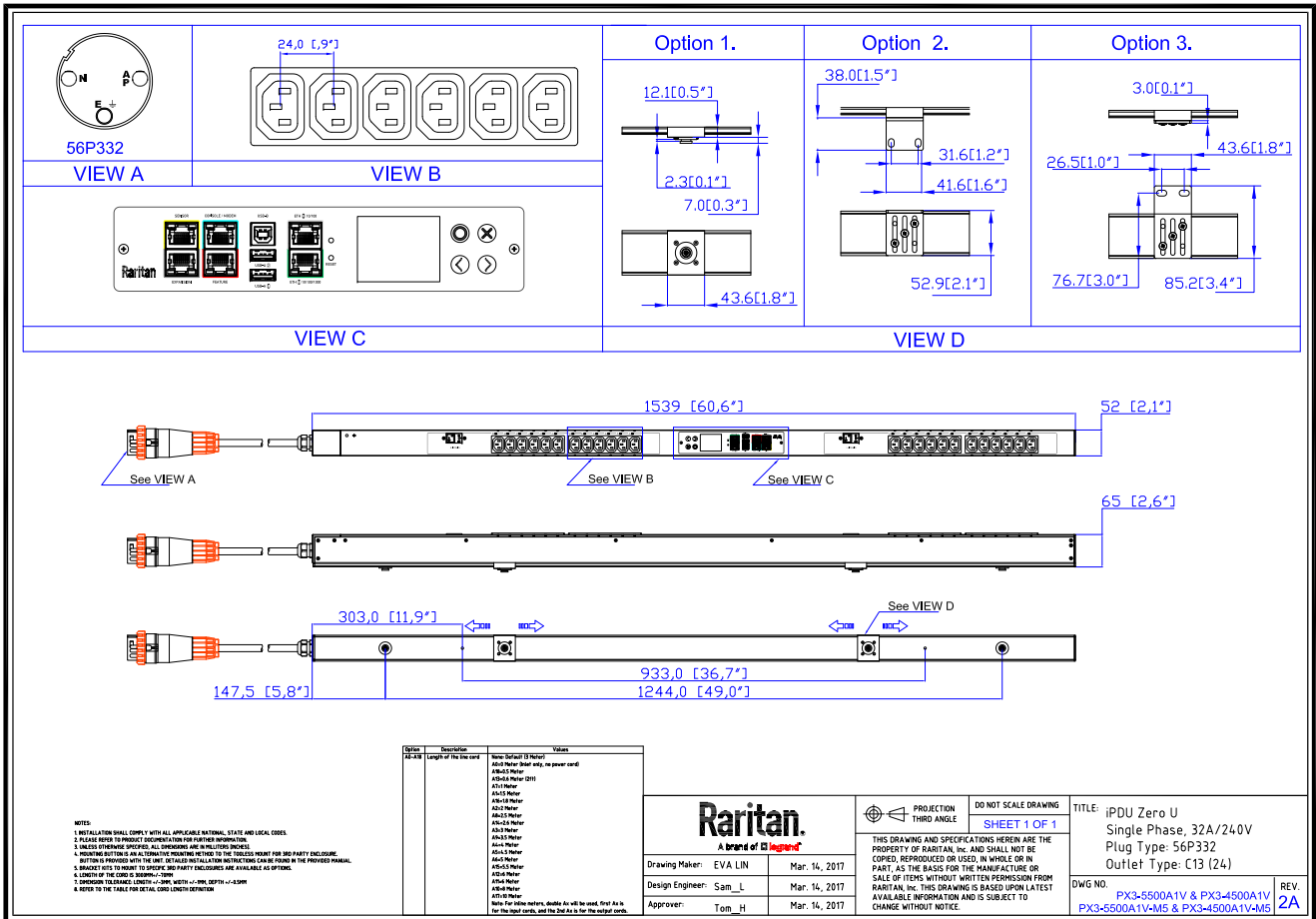

## Technical Specifications / Engineering Submittals

Raritan Model Number: PX3-5500A1V

rev20180528

### Mounting Diagram (G2-RACK-FOR-ZU)

250-70-0104-00



250-80-0011-00



250-70-0007-00

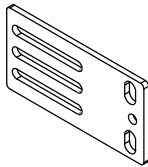
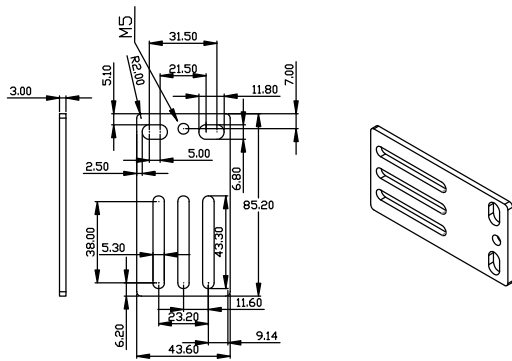

250-70-0093-00

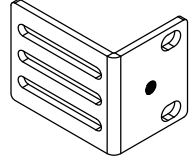
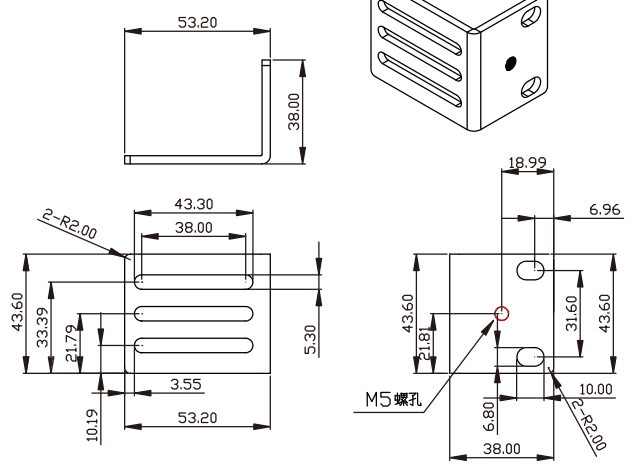

## Technical Specifications / Engineering Submittals

Raritan Model Number: PX3-5500A1V

rev20180528

### TRIP CURVE

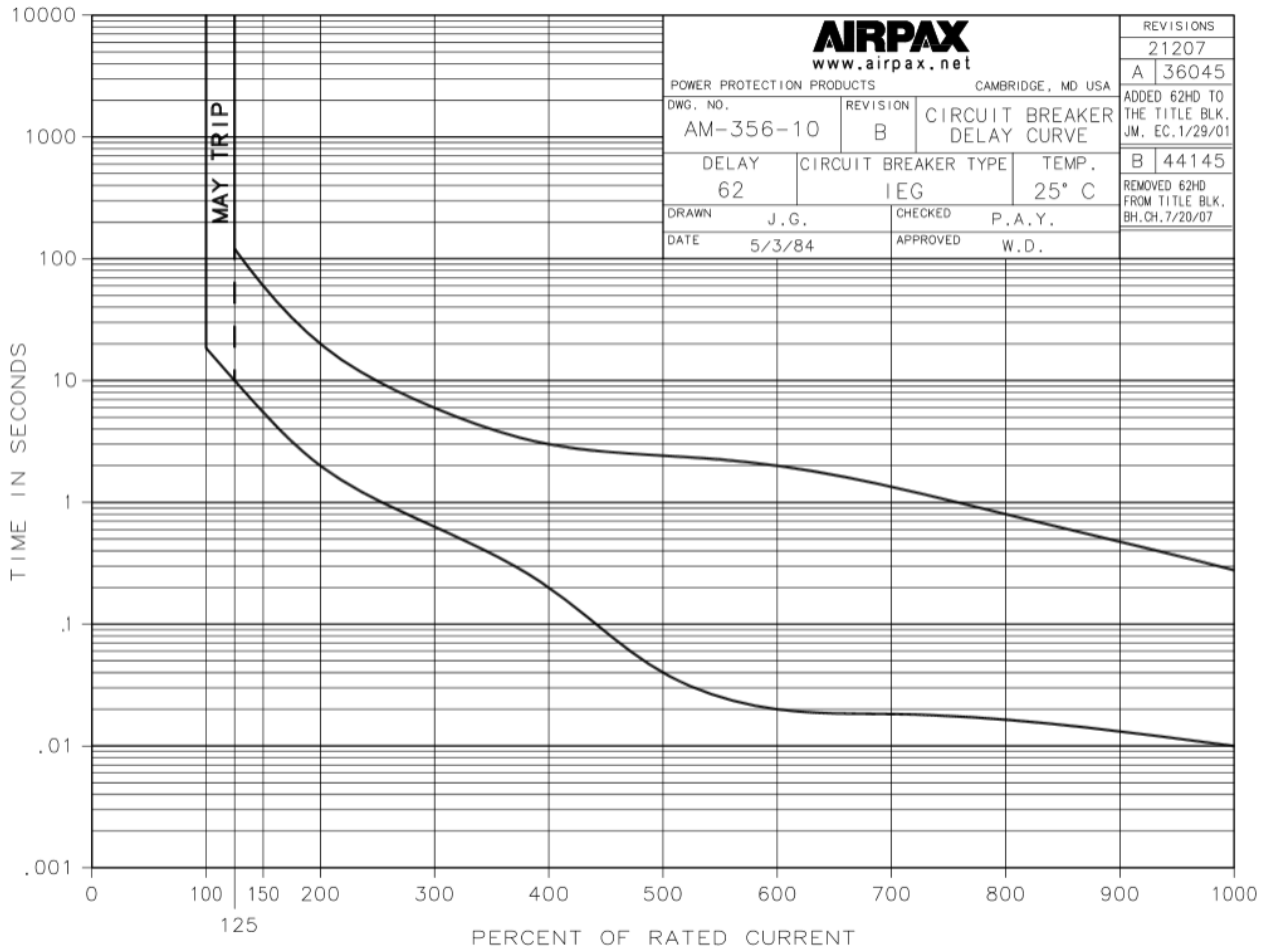

This file generated on: Mon, May 28, 2018 - 03:53:31