

IDS-509F Hardware Installation Guide Managed Industrial Ethernet Switches

THE SPECIFICATIONS AND INFORMATION REGARDING THE PRODUCTS IN THIS GUIDE ARE SUBJECT TO CHANGE WITHOUT NOTICE. ALL STATEMENTS, INFORMATION, AND RECOMMENDATIONS IN THIS GUIDE ARE BELIEVED TO BE ACCURATE BUT ARE PRESENTED WITHOUT WARRANTY OF ANY KIND, EXPRESS OR IMPLIED. USERS MUST TAKE FULL RESPONSIBILITY FOR THEIR APPLICATION OF ANY PRODUCTS.

This equipment has been tested and found to comply with the limits for a Class A digital device, pursuant to part 15 of the FCC rules. These limits are designed to provide reasonable protection against harmful interference when the equipment is operated in a commercial environment. This equipment generates, uses, and can radiate radio-frequency energy and, if not installed and used in accordance with this hardware guide may cause harmful interference to radio communications. Operation of this equipment in a residential area is likely to cause harmful interference, in which case users will be required to correct the interference at their own expense.

Modifications to this product not authorized by Perle could void the FCC approval and negate your authority to operate the product.

Perle reserves the right to make changes without further notice, to any products to improve reliability, function, or design.

Perle, the Perle logo, and IDS Switch are trademarks of Perle Systems Limited.

©2016. Perle Systems Limited.

Table of Contents

Preface	2
Overview	3
Switch Models Views	4
LED Indicators	7
Ports	9
Port Status Indicators	10
Terminal Block Connectors	11
DIP Switches	12
Installation	14
Cautions and Warnings	14
Terminal Block-Power Connectors	15
Grounding the IDS switch	15
Connecting Power to the IDS Switch	15
Wiring the Relay Alarm	16
Wiring Digital Inputs	17
Connecting the Console Port	18
Connecting Data Ports	20
Resetting the Switch	21
Configuring the IDS Switch	23
Appendix A - Technical Specifications	24
Appendix B - Sample Labels	27
Appendix C - Mechanical Drawings	28
Appendix D - DIN Rail and Wall Mounting	31
Appendix E - IDS Maintenance	33
Appendix F - Cables and Connectors	34

Preface

Audience

This guide is for the network or computer technician responsible for installing Perle IDS series switches. Familiarity with the concepts and terminology of Ethernet and local area networks is required.

Purpose

This document describes the hardware and physical characteristics of the Perle IDS switch. It covers hardware features as well as installation and operation of the switch. This document does not cover how to configure your Perle IDS switch. Information to configure your Perle IDS switch can be found in the User's Guide

Package Contents

- IDS switch with attached DIN rail mounting bracket
- Quick Start Guide

Document Conventions

This document contains the following conventions:

Most text is presented in the typeface used in this paragraph. Other typefaces are used to help you identify certain types of information. The other typefaces are:

Note: *Means reader take note:* notes contain helpful suggestions.

Caution: Means reader be careful. In this situation, you might perform an action that could result in equipment damage or loss of data.

Warning: IMPORTANT SAFETY INSTRUCTIONS

Means danger. You are in a situation that could cause bodily injury. Before you work on any equipment, be aware of the hazards involved with electrical circuitry and be familiar with standard practices for preventing accidents. Only qualified personnel should connect power to this unit.



Warning—more information is contained within this guide



Warning—equipment rated above 40°C. Equipment may be very hot.

Overview

This chapter discusses the following topics:

- LED Indicators
- Switch Model View
- Ports
- Port Status Indicators

The table below gives a brief overview of the models covered in this guide. For more details and for the most up-to-date list of models, please refer to the product pages at www.perle.com.

Standard Models	10/100/1000Base-T Ports	Fiber Ports	Temp
IDS-509F-XXXXXXX	8	1	Standard
IDS-509F2-XXXXXXX	7	2	Standard
IDS-509F3-XXXXXXX	6	3	Standard
IDS-509F-XXXXXXX-XT	8	1	Industrial
IDS-509F2-XXXXXXX-XT	7	2	Industrial
IDS-509F3-XXXXXXX-XT	6	3	Industrial

XXXXXXX - represents fiber ports of different wavelengths, distances and connectors

Switch Models Views

IDS-509F-xxxxxxx

IDS-509F-xxxxxxx-XT

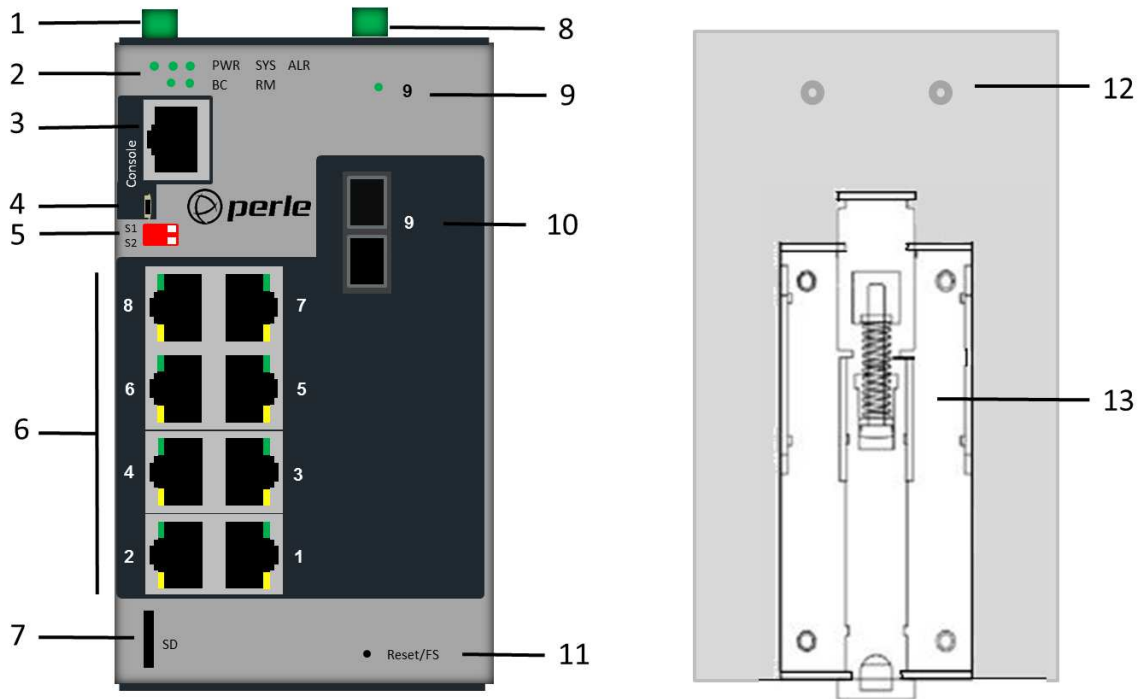

- | | |
|-----------------------------------|-------------------------------------|
| 1 – Terminal Block for Power 1, 2 | 8 – Terminal Block – Relay, I/O |
| 2 – Status LEDs | 9 – Fiber Status LED |
| 3 – Console Port – serial | 10 – 100Base-X Fiber port |
| 4 – Console Port – USB | 11 – Reset / FS (Fast Setup) |
| 5 – DIP switches | 12 – Wall Mount Bracket Screw Holes |
| 6 – 10/100/10100 Base-T Ports | 13 – DIN Rail Clip |
| 7 – SD Card Slot | |

IDS-509F2-xxxxxxx

IDS-509F2-xxxxxxx-XT

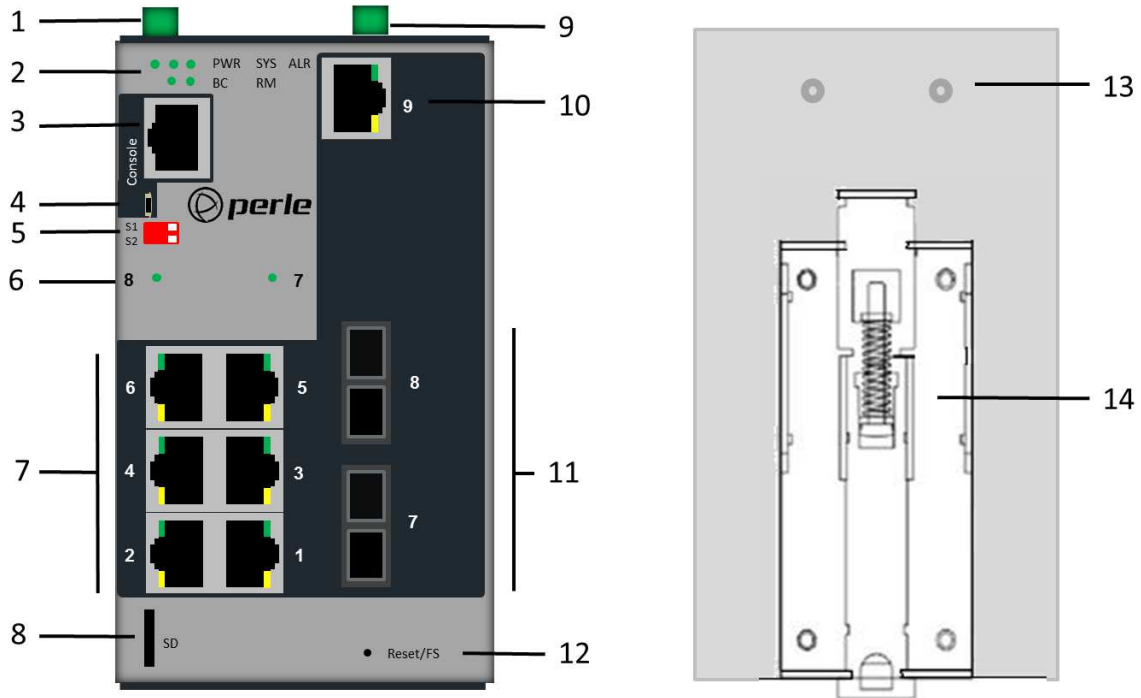

- | | |
|-----------------------------------|-------------------------------------|
| 1 – Terminal Block for Power 1, 2 | 8 - SD Card Slot |
| 2 – Status LEDs | 9 – Terminal Block – Relay, I/O |
| 3 – Console Port – serial | 10 – 10/100/1000 Base-T Port |
| 4 – Console Port – USB | 11 - 100Base-X Fiber Ports |
| 5 – DIP switches | 12 - Reset / FS (Fast Setup) |
| 6 – Fiber Port Status LEDs | 13 - Wall Mount Bracket Screw Holes |
| 7 – 10/100/1000 Base-T Ports | 14 - DIN Rail Clip |

IDS-509F3-xxxxxxx

IDS-509F3-xxxxxxx-XT

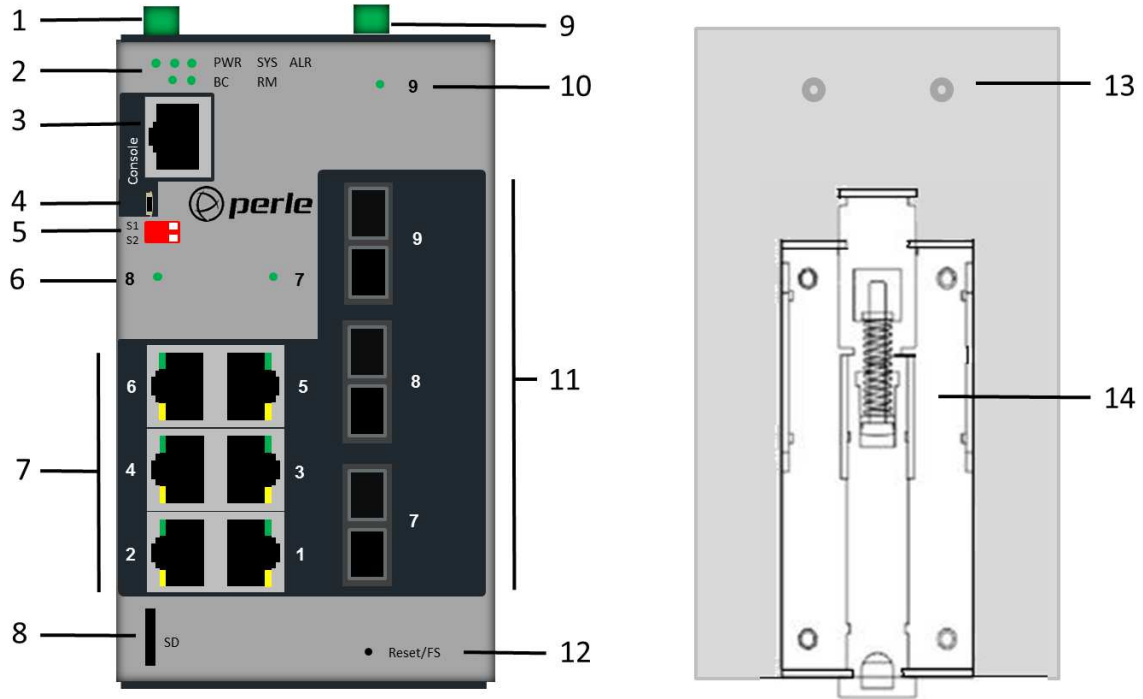

- | | |
|-----------------------------------|-------------------------------------|
| 1 – Terminal Block for Power 1, 2 | 8 - SD Card Slot |
| 2 – Status LEDs | 9 – Terminal Block – Relay, I/O |
| 3 – Console Port – serial | 10 - Fiber Port Status LED |
| 4 – Console Port – USB | 11 - 100Base-X Fiber Port |
| 5 – DIP switches | 12 - Reset / FS (Fast Setup) |
| 6 – Fiber Port Status LEDs | 13 - Wall Mount Bracket Screw Holes |
| 7 – 10/100/1000 Base-T Ports | 14 - DIN Rail Clip |

LED Indicators

P (Power Inputs)

State	Description
Green	P1 and P2 Power inputs within specifications
Yellow	P1 or P2 Providing power within specifications
Red	Neither P1 or P2 providing power within specifications

Sys (System Status)

State	Description
Green - blinking (after power on)	System booting
Green - solid	System ready/operating normally
Green - blinking slowly	Fast Setup Mode activated/port available
Green - blinking fast	Fast Setup Mode activated/no port available
Red	Hardware fault or firmware load error

Alr (Alarm)

State	Description
Off	No alarms configured
Green - solid	Alarms configured, but no alarms detected
Red - solid	Alarm condition detected
Red - blinking	Alarm condition detected and Alarm Relay activated

BC (Backup Coupling)

State	Description
Off	Backup Coupling not enabled
Green - solid	Backup Coupling Link enabled

RM (Ring Master)

State	Description
Off	Ring Master not activated
Green - solid	Ring Master Active, redundant port blocked. Coupling Link enabled
Green - flashing	Ring Master unable to establish a ring due to missing link on one of the Ring ports
Yellow - solid	Ring Master Active, redundant port unblocked - indicates a break in the Ring

Ports

10/100/1000Base-T Ports

These ports provide the standard gigabit Ethernet interface. They provide speeds of 10/100 or 1000 Mb/s through twisted pair (UTP) cables of up to 100 meters (328ft) in length.

100Base-X fiber Ports

These ports are built in fiber modules that provide 100Base-X (100Mb/s) fiber connectivity. These fiber ports are available on the switches in a variety of distances and wavelengths. SC or ST connectors are available as well as single mode, multi mode, duplex and simple models. Consult the full model list at www.perle.com

RJ-45 Console Port

This is a console management port providing access to the switch management function using the industry standard CLI command set. This port has an RJ-45 connector. See RJ-45-Console Port Pinouts.

USB Console Port

The MicroUSB port is an alternative connection to the switch's console. This provides access to the switch management function using the industry standard CLI command set. When connected the port presents a serial interface that can be used from a PC Terminal emulation program (such as PuTTY).

Power Connector

The power input connector has provisions for dual inputs. Two independent power sources can be used to power the switch. If one power input fails, the other power input will power the switch.

Alarm Relay Connector

The Alarm Relay can be energized by the software or hardware under certain conditions. It can then be used to trigger an external alarm circuit such as a light or sounding device. This connector provides both Normally opened (NO) and Normally Closed (NC) dry contact on the connector block, both are associated with the same relay.

Digital Input Connector

Two Digital Inputs are provided that can be used for the generation of alarms (SNMP trap, energizing of on board Alarm Relay etc.).

Port Status Indicators

Ethernet Port Status Indicators

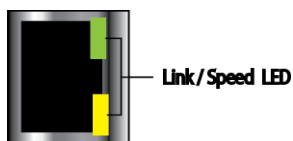

Port Link / Speed (Green and Yellow LEDs)

State	Description
Green	1000 Mbps
Green / Yellow	100 Mbps
Yellow	10 Mbps
On solid	Port Link
Random blinking	Port Link and Activity
Slow blinking	Error disabled
Rapid blinking	Port in Fast Setup Mode

Fiber Port Status Indicators

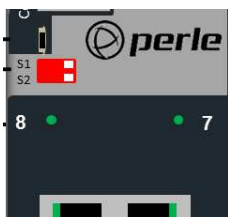

Port Link

State	Description
Green	Link
Green Flashing	Link/Activity

Terminal Block Connectors

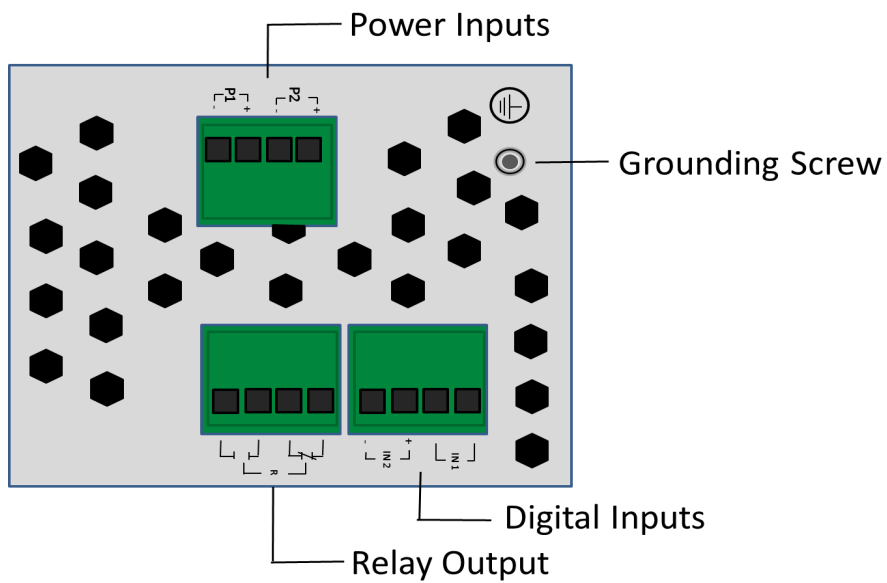

P1 - Power Input 1

P2 - Power Input 2

IN 1 - Digital Input 1 - Dry Contact

IN 2 - Digital Input 2 - Wet Contact

R - Relay with 2 connection points - Normally Open (NO) / Normally Closed (NC)

DIP Switches

The DIP switches on the IDS switch provide a quick and easy way to setup a Ring in order to achieve improved network reliability and faster recovery times from network faults. A Ring can also be setup and configured from any of the software configuration methods. Software configuration methods provide access to additional parameters as well as the more advanced Ring features.

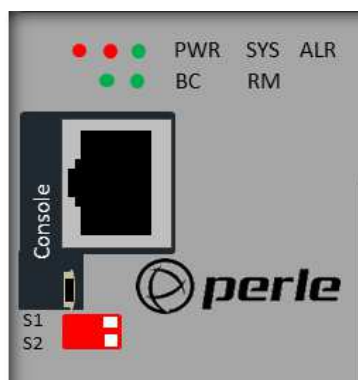

DIP Switch		Ring Feature		
SW1	SW2	Ring Role	Coupling Mode	Description
On	On	--	--	Software control - Ring Master functionality is controlled by software configuration.
On	Off	Master	Primary	Ring Feature: enabled Ring Role: Master Coupling: Active on Port: 4 (Note 1)
Off	On	Client	Standby	Ring feature: enabled Ring Role: Client Coupling: Backup on Port 4 (Note 1)
Off	Off	Client	Primary	Ring Feature: enabled Ring Role: Client Coupling: none
<p>Note 1: If the backup coupling feature is not used, then port 4 can be used as a normal connection port.</p>				

Port Assignment

Ring Ports	1, 2
Coupling Port	4

Note: DIP switches are read during system boot up. If a DIP switch is changed the IDS switch must be rebooted in order for the change to take effect.

Installation

This chapter discusses the following topics:

- Cautions and Warnings
- Terminal Block-Power Connectors
- Grounding the IDS Switch
- Connecting Power to the IDS Switch
- Wiring the Relay Alarm
- Connecting the Console Port
- RJ45 Console Port
- Resetting the Password
- Connecting Destination Ports
- Configuring the IDS Switch

Cautions and Warnings

General Cautions and Warnings

Warning: Power sources must be off prior to beginning the power connection steps. Read the installation instructions before you connect the unit to its power source.

Warning: Ensure that the voltage and current ratings of the intended power source are appropriate for the IDS switch as indicated on the product label.

Warning: Ensure that the installation and electrical wiring of the equipment is performed by trained and qualified personnel and that the installation complies with all local and national electrical codes.

Warning: This unit should be installed in a restricted access location where access can only be gained by service personnel or users who have been instructed about the reasons for the restrictions applied to the location and about any precautions that shall be taken; and access is through the use of a tool or lock and key, or any means of security, and is controlled by the authority responsible for the location.

Warning: If the unit is installed vertically in a living or office environment, the device must be operated exclusively in switch cabinets with fire protection characteristics in accordance with EN-60950-1

Warning: The working voltage inputs are designed for operation with Safety extra low Voltage (SELV). Connect only to SELV circuits with voltage restrictions in line with IEC/EN 60950-1.

Hazardous Location Warnings

Warning: This equipment shall be installed in an enclosure that provides a degree of protection not less than IP54 in accordance with EN-60079-15 and accessible only by the use of a tool.

Warning: The equipment shall only be used in an area of not more than pollution degree 2, as defined in IEC 60664-1.

Warning: These devices are open-type devices that are to be installed in an enclosure with tool removable cover or door, suitable for the environment.

Warning: This equipment is suitable for use in Class 1, Division 2, Groups A, B, C, D, or only non-hazardous locations.

Warning: WARNING-EXPLOSION HAZARD - Do not disconnect equipment unless power has been removed or the area is known to be non-hazardous.

Warning: WARNING-EXPLOSION HAZARD - Substitution of any components on this switch may impair suitability for Class 1, Division 2.

Warning: Transient protection shall be provided that is set at a level not exceeding 140% of the peak rated voltage value at the supply terminals to the equipment.

Warning: Ensure power has been removed at the source of the alarm circuit prior to proceeding with the connections to the alarm relay.

Warning: Ensure that voltage and current supplied by the alarm circuits are within the stated Alarm Relay specifications.

Warning: In hazardous location installations, failure to remove from the source prior to completing the wiring connections to the alarm relay could cause an electrical arc resulting in a possible explosion.

Warning: Power supply of the equipment must be rated appropriately (see Appendix for specifications) with limited power. Limited power means complying with one of the following requirements.

Class 2 circuit according to Canadian Electrical Code, Part 1, C22.1

Class 2 circuit according to National Electrical Code, NFPA-70

Limited Power Supply (LPS) according to EN/IEC 60950-1;

Limited-energy circuit according to EN/IEC 61010-1

Warning: If this equipment is used in a manner not specified by the manufacturer, the protection provided by the equipment may be impaired.

Warning: In case of malfunction or damage, no attempts at repair should be made. Do not dismantle the product. All repairs need to be made by a qualified Perle representative.

Warning: Explosion hazard. Do not remove or replace lamps, fuses or plug-in modules (as applicable) unless power has been disconnected or the area is free of ignitable concentrations.

Warning: Explosion hazard. Do not disconnect while the circuit is live or unless the area is free of ignitable concentrations.

Terminal Block-Power Connectors

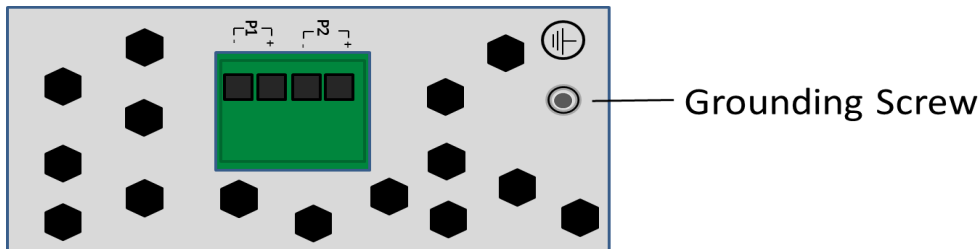

Grounding the IDS switch

If your installation requires additional grounding, follow this procedure.

Grounding the chassis requires the following items:

- One grounding lug (not provided)
- One 12AWG wire (not provided)

Follow the manufacturers instructions for attaching the ground wire to the grounding lug. Attach the grounding lug to the chassis and secure with the grounding screw provided.

Connecting Power to the IDS Switch

The IDS switch has two power inputs that can be connected simultaneously to provide redundant power. If one power source fails the other source acts as a backup, and powers the switch

Wiring with suitable temperature ratings must be used. Refer to specification section for details.

1. Ensure the power source is off prior to connection
2. Strip both (12-20AWG) wires 7-8 mm(5/16th)
3. Loosen the terminal block screws and connect positive (+) / negative (-) wires into the +/- terminals
4. Tighten terminal screws (0.5Nm torque). Ensure the wires are securely fastened.
5. Re-insert the Terminal Block connector it removed, Turn on power source. Check LED indicators in the guide for power status

6. Connect P2 (power source 2, beginning at Step 1)
7. Ensure that there is one individual conductor for each clamping point.

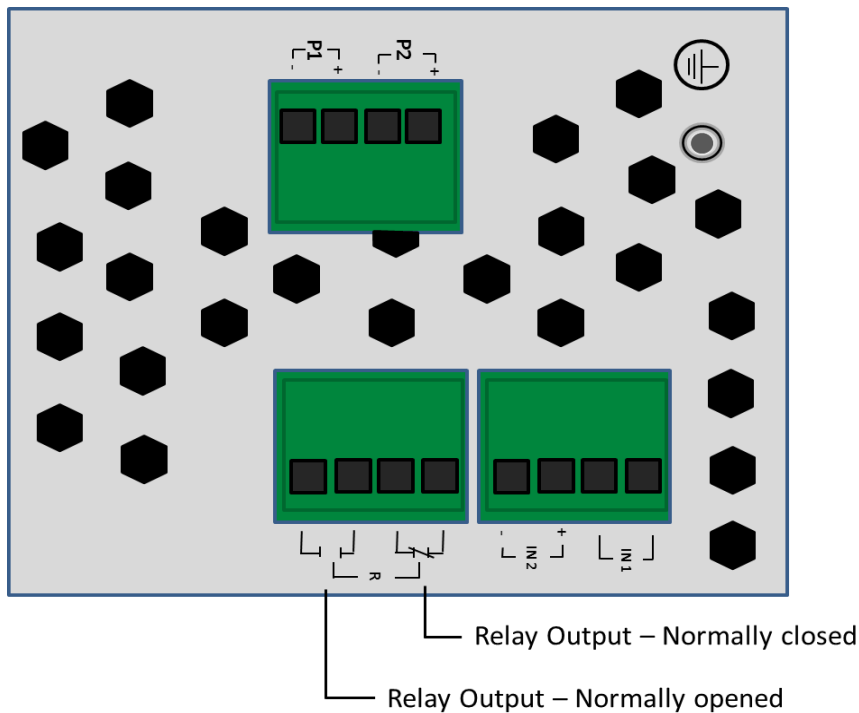

Wiring the Relay Alarm

The IDS switch has a relay with a Normally Closed (NC) terminal pair as well as a Normally Open (NO) one. Select the connection that suits the application. These terminals are located on the top panel of the unit. The IDS switch can be connected to an external powered device such as a siren or light for visual or audible notification of an alarm status.

1. Ensure the power source is off prior to connection.
2. Strip 2x12-20AWG (3.31 mm² -0.52 mm²) twisted pair copper wires 7-8 mm.
3. Loosen the terminal block screws and connect wires into the terminals.
4. Tighten terminal screws. Ensure the wires are securely fastened.
5. Re-insert the Terminal block connector if removed.
6. Turn on power source.

Warning: Ensure power has been removed at the source of the alarm circuit prior to proceeding with connections to the alarm relay.

Warning: Ensure the voltage and current supplied by the alarm circuits are within the stated Alarm Relay specifications.

Warning: In hazardous location installations, failure to remove the power from the source prior to completing the wiring connections to the alarm relay could cause an electrical arc resulting in a possible explosion.

Wiring Digital Inputs

The IDS switch has two digital input connections, one to sense a Dry Contact and one to sense a Wet Contact.

IN1: This can sense a dry contact. On this terminal pair the IDS switch provides a voltage and current and can monitor the opening and closing of a dry contact switch.

IN2: This can sense a wet contact. On this terminal pair the IDS switch provides no voltage but relies on the input circuit to provide this. See specifications for values.

To connect these:

1. Ensure the power source is off prior to connection.
2. Strip 2x12-20AWG (3.31 mm² -0.52 mm²) twisted pair copper wires 7-8 mm.
3. Loosen the terminal block screws and connect wires into the terminals. For IN2, ensure that the live side of the input circuit is connected to the + terminal and the return to the -.
4. Tighten terminal screws. Ensure the wires are securely fastened.
5. Re-insert the Terminal block connector if removed.
6. Turn on power source.

Warning: Ensure power has been removed at the source of the alarm circuit prior to proceeding with connections to the alarm relay.

Warning: Ensure the voltage and current supplied by the alarm circuits are within the stated Digital Input specifications.

Warning: In hazardous location installations, failure to remove the power from the source prior to completing the wiring connections to the alarm relay could cause an electrical arc resulting in a possible explosion.

Connecting the Console Port

The IDS switch can be fully configured and managed from the console port. The console ports provide direct access to the Command Line Interface (CLI). The MicroUSB console port has priority on a reboot of the switch and will be activated first. If no USB console port session is detected then the RJ45 console port will then be activated. See appendixes for console port pinouts.

RJ45 Console Port

The console port is an 8-pin female connector (with DTE pinouts).

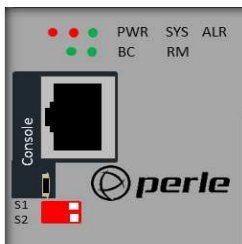

1. Connect an RJ45 cable to the IDS switch console port (RJ45) and the other end of the cable to a COM port on your PC.
2. Choose Start > Control Panel > Systems or equivalent on the Windows Operating System you are using.
3. Click the Hardware tab and choose Device Manager, Expand the Ports(COM & LPT) section. This will expand the drop down to show the number of com ports on your system. Connect the cable to one of these ports (probably com1 or com2).
4. Start a terminal-emulation program (such as Putty or SecureCRT) on the COM port where you have connected the cable PC.
5. Configure this COM port within the terminal emulation program with the following parameters:
 - 9600 baud
 - 8 data bits
 - 1 stop bit
 - No parity
 - None (flow control)
6. Connect power to the switch as described in Connecting Power to the IDS Switch.
7. The PC will display the bootloader sequence.
8. When the booting (see Booting, Resetting the Switch) of the IDS is completed, press Enter to display the setup prompt.

Warning: If you connect or disconnect the console cable with the power applied to the switch or any device on the network, an electrical arc can occur. This could cause an explosion when installed in a hazardous location. Ensure the power is removed from all devices prior to making the cable connection.

MicroUSB Console Port

1. Connect a USB cable to the PC's USB port, then connect the other end of the cable to the IDS switch's micro-B USB connector.
2. Connect power to the switch as described in **Connecting Power to the IDS Switch**
3. On the PC Choose Start -> Control Panel -> Systems (or equivalent) on the Windows Operating System, then open the Hardware tab. Choose the Device Manager, and expand the Ports section. The assigned COM port appears can be identified.
4. Start an terminal-emulation program (such as Putty or SecureCRT) on the com port where you have connect the cable to the PC.
5. Configure your COM port within the emulation program on the PC as:
 - 9600 baud
 - 8 data bits
 - 1 stop bit
 - No parity
 - None (flow control)
6. The PC will display the bootloader sequence.
7. Press Enter to display the setup prompt when the booting of the IDS is completed.

Warning: If you connect or disconnect the console cable with the power applied to the switch or any device on the network, an electrical arc can occur. This could cause an explosion when installed in a hazardous location. Ensure the power is removed from all devices prior to making the cable connection.

Connecting Data Ports

Ethernet Connections

By default all of the 10/100/1000 ports will automatically set themselves up to match the speeds of all attached devices. If auto negotiation is not supported by one or more attached devices, the ports can be configured to operate at fixed speeds and duplex settings.

Warning: In hazardous location installations, failure to remove the power from the source prior when completing the wiring connections to the Ethernet ports could cause an electrical arc resulting in a possible explosion.

To connect to 10Base-T, 100Base-TX or 1000Base-T follow these steps:

1. When connecting to devices, workstations, servers or routers connect a straight through Ethernet cable to a 10/100/1000 RJ45 connector on the front of the IDS switch. Gigabit Ethernet requires CAT5 or better.
2. Once the device is connected and link is established the link LEDs will turn on. These LEDs will indicate whether you have a 10,100 or 1000 Mb/s link to the switch. See. (LED Indicators) for more details.

Note: It may take a few seconds for the device to become active. By default the IDS switch will have Rapid Spanning Tree (RSTP) protocol enabled. This protocol will first check the network for any cabling loops prior to bringing the port up, in order to prevent network disruptions.

Fiber Connections

To connect to 100Base-X follow these steps:

1. Connect 100Base-X devices to the fiber ports using appropriate fiber cables. Ensure that cable implements the proper the TX to RX crossover
2. Once the device is connected and link is established the link LEDs will turn on. The LED will begin to flash once data activity is initiated. See. (LED Indicators) for more details.

Note: It may take a few seconds for the device to become active. By default the IDS switch will have Rapid Spanning Tree (RSTP) protocol enabled. This protocol will first check the network for any cabling loops prior to bringing the port up, in order to prevent network disruptions.

Resetting the Switch

The Reset/Fast Setup button is located near the bottom of the switch. A small tool such as a paper clip is needed to access the recessed button.



Soft Reset

To reset/restart the switch you can perform a soft reset. Press and immediately release the reset button to perform a soft reset.

LED	Behavior
PWR	The PWR LED will remain solid yellow during the boot process. Once the system software has been loaded the PWR LED will reflect the status of the power inputs.

Hard Reset

Hard Reset performs a power-off of the switch without requiring a disconnection of power. Once powered off, the switch can be powered back on by pressing the reset switch again or by disconnecting power at source and re-applying.

Press and hold the reset button for at least 8 seconds. The switch will perform a complete power down and stay in the powered off state. Press the reset button again to power the switch on.

LED	Behavior
ALL	All LEDs will be off after 8 seconds.

Reset to Factory Default Configuration

The switch can be reset to the Factory default configuration. When this is done, all configuration, user IDs, passwords and security certificates are deleted. The start-up and backup software are unaffected. Follow this procedure:

- Power off the switch
- Press and hold the reset button
- While continuing to hold the reset button, apply power to the switch
- ALR LED will go on after power up; when it goes out, release the reset button

The switch is now reset to factory default configuration.

Booting the Switch

When first applying power to the IDS switch, it will startup and go through the boot process. The LEDs will behave according to the table below.

LED	Behavior
PWR	Yellow during the booting process. Once the system software has been loaded, the PWR LED will reflect the status of the power inputs.
SYS	Green blinking - Boot process underway.

Fast Setup Mode

This allows you to perform initial configuration of the switch using your Web browser. Fast Setup Mode can be activated when the switch is in Factory Default. When started up in this mode, the switch assigns itself an IP address and also assigns an IP address to the connected PC. This makes it possible to initiate a Web session and the use of the Fast Setup configurator. Switches are shipped in Factory default mode. Refer to the Quick Start Guide that came with the switch for instructions on how to connect to the switch for the first time.

LED	Behavior
PWR	Press and hold the Reset/FS button. Release button when LED changes from Red to Yellow.
Port Link / Speed	Rapid blinking on the first available RJ-45 port to which the PC can be connected.

Password Recovery

When the switch is not in factory default, the "Fast Setup Mode" sequence will activate Password recovery.

Note: The password recovery feature can be disabled in the software.

LED	Behavior
ALR	On solid - during reset process Off - to indicate that reset has completed

Configuring the IDS Switch

The IDS switch can be configured, operated and monitored using any of the following methods. See the IDS User's Guide for more details.

CLI

A text-based Command Line Interface based on industry standard syntax and structure. The CLI can be accessed from the console port. Once a valid IP address is configured on the switch, Telnet, SSH or the Web interface can also be used to access the switch for administration purposes. See the IDS Command Line Reference Guide for more information.

Web Device Manager

The Perle Web Device Manager is an embedded Web based application that provides an easy to use browser interface for managing the switch. This interface provides the ability to configure and manage the switch. This is accessible through any standard desktop web browser. Requires the switch to have a valid IP address.

Fast Setup

This utility provides the ability to do either an initial setup (out of the box) or a recovery setup. In order to use this utility a PC must be connected to one of the switches data ports and the function is activated using the reset button on the front panel.

SNMP

The switch can be managed with an SNMP compatible management station that is running platforms such as HP Openview or Perle's PerleVIEW NMS.

Appendix A - Technical Specifications

Technical Specifications	
Power	
Power Connector	<ul style="list-style-type: none"> 4-Pin Removable Terminal Block Grounding screw on metal chassis Dual Power Input
Input Voltage	<ul style="list-style-type: none"> 12/24/48 VDC Nominal(9.6 to 60 VDC) - 2.0A Max 24 VAC Nominal (18-30 VAC) - 1.6A Max
Alarm Relay	<ul style="list-style-type: none"> NO (Normally Open), NC (Normally Closed contacts) 1.0A @ 24VDC or 0.5A @ 48VDC Requires Class 2/LPS or SELV circuit with Fuse protection
Digital Input: IN1	<ul style="list-style-type: none"> Connects to Dry Contact Circuit Provides: 12V, 36mA On: > 2.1mA (< 4K Ohms) Off: < 1.2mA (>9K Ohms)
Digital Input: IN2	<ul style="list-style-type: none"> Connect to Wet Contact Circuit (requires external power) Input Voltage Rating: -36 to +36 VDC Input Impedance: 4K Ohms On: >10VDC Off: <5VDC
Rated Cable Temperatures IDS-509F IDS-509F-XT	>74° C >113° C
Overload Current Protection	Fuse
Reverse polarity protection	Yes
Interfaces	
10/100/1000Base-T (RJ45)	<ul style="list-style-type: none"> Up to 100 meters (328 ft.) Auto-negotiation Auto-MDI/MDIX Ethernet isolation 1500 V
100Base-X Fiber Ports	<ul style="list-style-type: none"> 100Base-X in a variety of wavelengths, distances and connectors
Console port	<ul style="list-style-type: none"> RJ45 DTE - serial port MicroUSB Type B female port - serial interface
Switch properties	

Technical Specifications	
Standards	IEEE 802.3 for 10Base-T IEEE 802.3u for 100Base-TX IEEE 802.3ab for 1000Base-T IEEE 802.3x for Flow Control
Environmental Specifications	
Operating Temperature Ranges IDS-509F IDS-509F-XT	-10° C to 60° C (14° F to 140° F). -40° C to 75° C (-40° F to 167° F)
Storage Temperature Range IDS-509F IDS-509F-XT	-25° C to 70° C (-13° F to 158° F) -40° C to 85° C (-40° F to 185° F)
Operating Humidity Range	5% to 90% non-condensing
Storage Humidity Range	5% to 90% non-condensing
Operating Altitude	Up to 3,048 meters (10,000 feet)
Standards and Certifications	
Safety	UL 60950-1 IEC 60950-1:2005+A1:2009 and EN 60950-1:2006+A11:2009+A1:2010+A12:2011 CE Mark
Industrial Safety	UL 61010-1 and UL 61010-2-201 (Formerly UL508)
Emissions	FCC 47 Part 15 Class A CISPR 22:2008/EN55022:2010 (Class A) CISPR 24:2010/EN 55024:2010
EMC and Immunity	CISPR 24:2010/EN 55024:2010 IEC/EN 61000-4-2 (ESD) IEC/EN 61000-4-3 (RS) IEC/EN 61000-4-4 (EFT) IEC/EN 61000-4-5 (Surge) IEC/EN 61000-4-6 (CS) IEC/EN 61000-4-8 (Magnetic Field) IEC/EN 61000-6-2 (General Immunity in Industrial Environments)
Hazardous Locations (Hazloc)	ANSI/ISA 12.12.01, Class 1 Division 2 Groups A-D* ATEX Zone 2 *
* pending	

Contacting Technical Support

Contact information for the Perle Technical Assistance Center (PTAC) can be found at the link below.

www.perle.com/support_services/support_request.shtml





Warranty / Registration

This product is covered by the Perle Ethernet Switches Warranty. Details can be found at: https://www.perle.com/support_services/warranty.shtml

Appendix B - Sample Labels

perle
 Model: IDS-509F3-C2MD2-SD20
 P/N: 07013910
 S/N: 330-353813T00113



CE FC    

Input : 9.6-60VDC 2.0A max, Class2
 18-30VAC 50-60Hz. 1.6A max, Class2
 MAC : 0040029101E6

 **II 3G**
 DEMKO 16 ATEX 1636X
 II 3 G Ex nA nC IIC T5 Gc
 -10°C ≤ Tamb ≤ 60°C
 Rated Cable Temp. >74°C





 **LISTED E465984**
 IND. CONT. EQ.
 FOR HAZ. LOC.
 Class I, Division 2,
 Groups A, B, C and D
 Temp Code T5
 Max. Ambient 60 Deg. C
 Min. Ambient -10 Deg. C

 **LISTED E160409**
 I.T.E.
E466997
 IND. CONT. EQ.
 Surrounding Air Temp.
 Max. 60 Deg. C
 Min. -10 Deg. C
 Made in Canada

60 Renfrew Drive,
 Markham, Ontario,
 Canada. L3R 0E1
 Class 1 Laser Product: IEC 60825-1

perle
 Model: IDS-509F3-C2MD2-SD20-XT
 P/N: 07014150
 S/N: 330-593813T00115



CE FC    

Input : 9.6-60VDC 2.0A max, Class2
 18-30VAC 50-60Hz. 1.6A max, Class2
 MAC : 0040029101FA

 **II 3G**
 DEMKO 16 ATEX 1636X
 II 3 G Ex nA nC IIC T4 Gc
 -40°C ≤ Tamb ≤ 75°C
 Rated Cable Temp. >90°C

 **LISTED E465984**
 IND. CONT. EQ.
 FOR HAZ. LOC.
 Class I, Division 2,
 Groups A, B, C and D
 Temp Code T4
 Max. Ambient 75 Deg. C
 Min. Ambient -40 Deg. C

 **LISTED E160409**
 I.T.E.
E466997
 IND. CONT. EQ.
 Surrounding Air Temp.
 Max. 75 Deg. C
 Min. -40 Deg. C

60 Renfrew Drive,
 Markham, Ontario,
 Canada. L3R 0E1
 Class 1 Laser Product: IEC 60825-1

Made in Canada

Appendix C - Mechanical Drawings

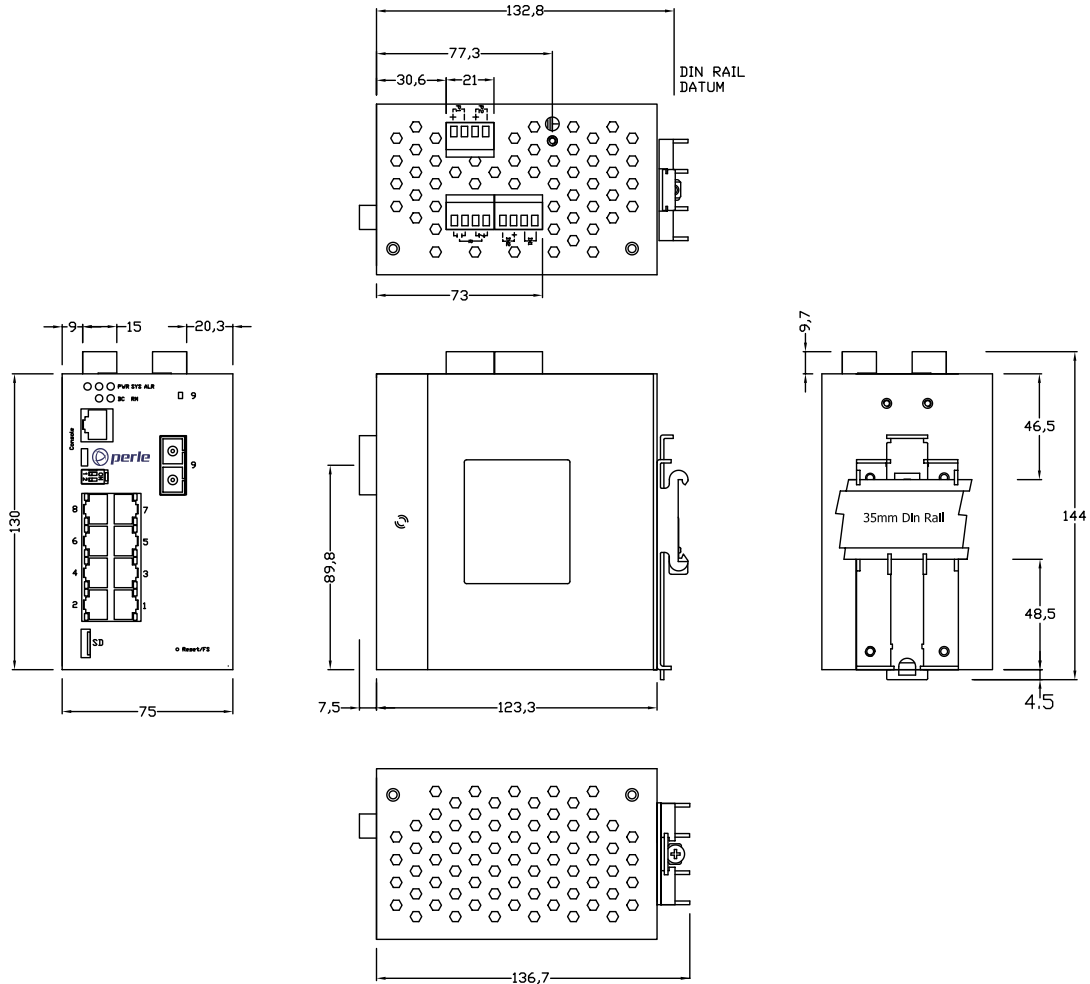

8RJ + 1 Fixed Fiber

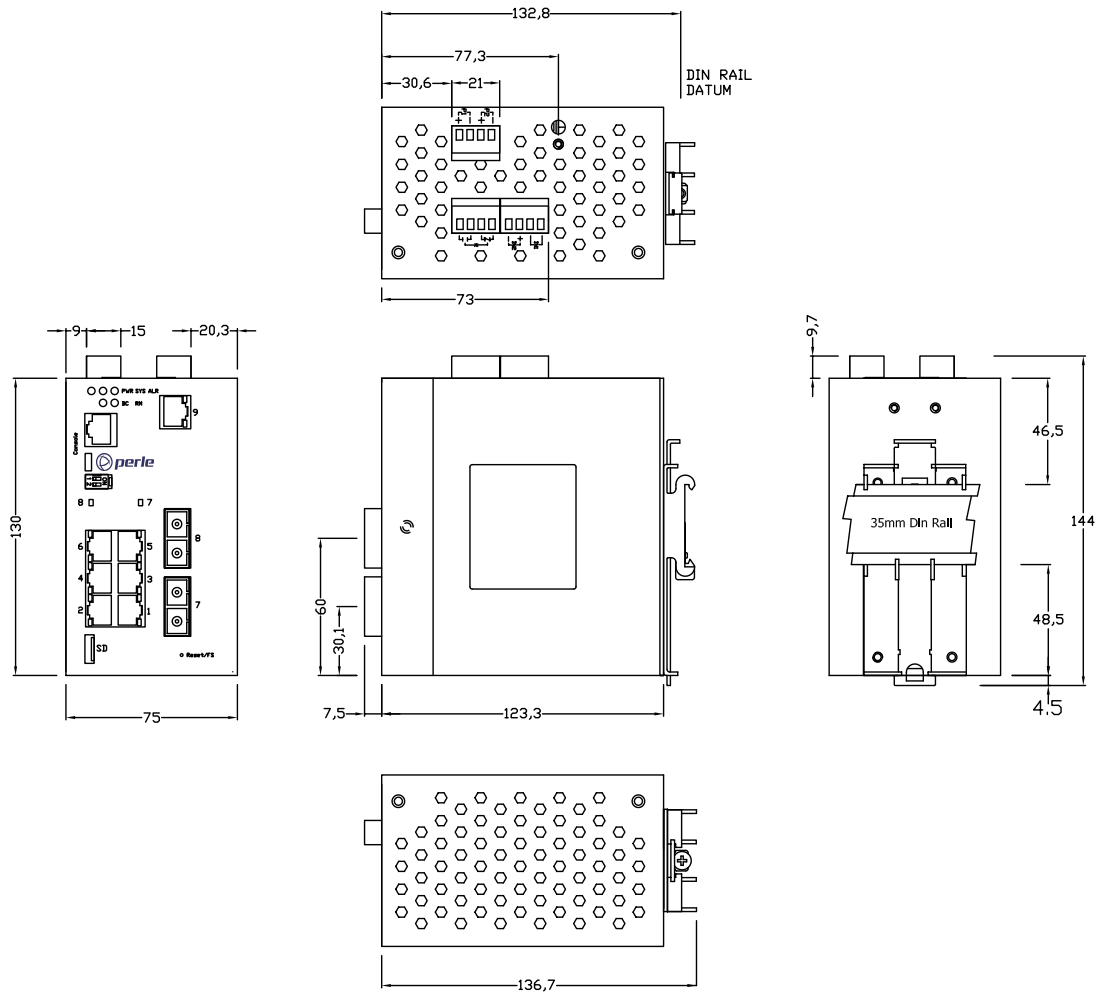

7RJ + 2 Fixed Fiber

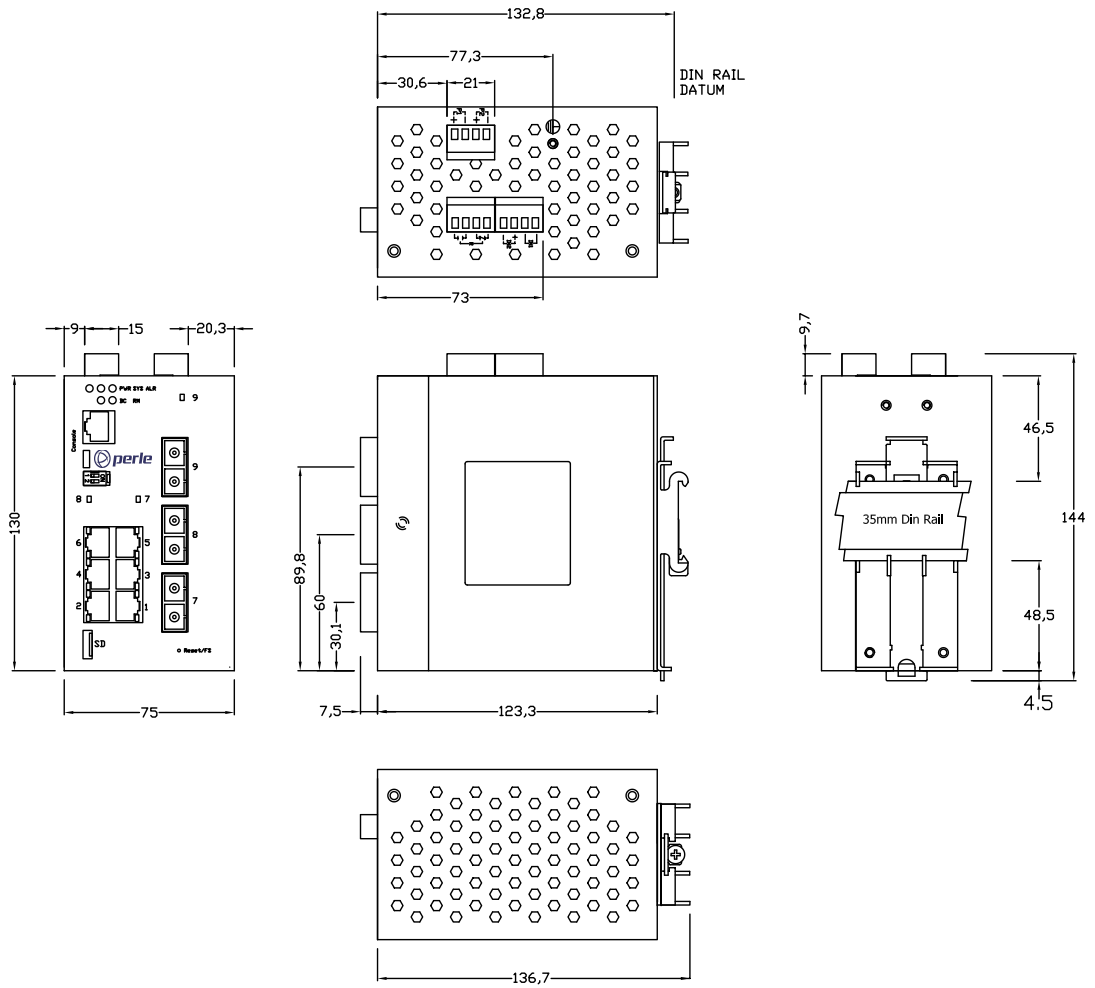

6RJ + 3 Fixed Fiber

Appendix D - DIN Rail and Wall Mounting

This appendix provides instruction on the following:

- Mounting the IDS Switch on a DIN Rail
- Removing the IDS from the DIN Rail
- Wall Mounting the IDS

Mounting the IDS Switch on a DIN Rail

1. The DIN rail clip will be fixed to the back of the IDS unit when you receive the switch.
2. Position the IDS switch such that the top hooks of the DIN rail clip attach onto the top of the DIN rail.
3. Rotate the bottom of the IDS switch towards the rail. This will snap the bottom hooks of the DIN rail clip onto the bottom of the DIN rail.

See diagram below



Removing the IDS from the DIN Rail

1. The DIN rail attachment clip has a slot at the bottom of the latch that is visible beneath the switch when it is mounted.
2. Insert a flat blade screwdriver into the slot and twist the base to release the clip. Alternatively a downward force on the clip will release the clip.
3. When the clip is released, pull the bottom of the switch out slightly and remove the switch from the DIN rail.



Wall Mounting the IDS

If you have purchased the optional wall mounting kit then proceed as below:

1. Remove the DIN rail clip from the rear panel on the IDS switch.
2. Attach the wall mount plates to the IDS switch as shown below using the screws provided in the kit.

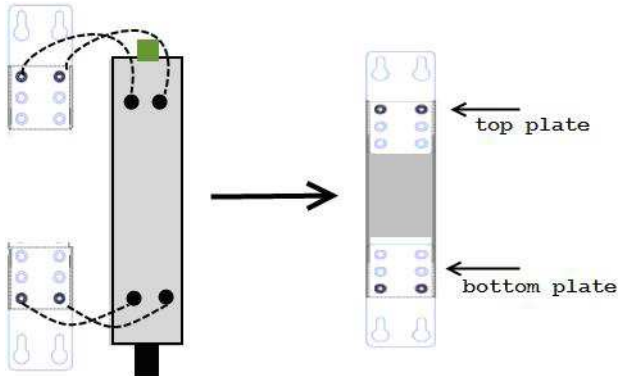

3. Use the wall mount plates as a guide to mark the spot where the screws will be placed.
4. Drive the screws into the wall leaving about 2 mm of the screw protruding from the wall to allow room for sliding the wall mount panel between the wall and the screws.
5. Once the screws are fixed to the wall, insert the four screw heads through the large parts of the keyhole shaped screw openings
6. Pull the IDS switch down to lock the IDS switch to the wall mount.
7. Tighten the four screws securely to the wall.

Note: for best results use screws with the following attributes Head diameter .5 - .6 mm
Shaft diameter 3 -3.5 mm

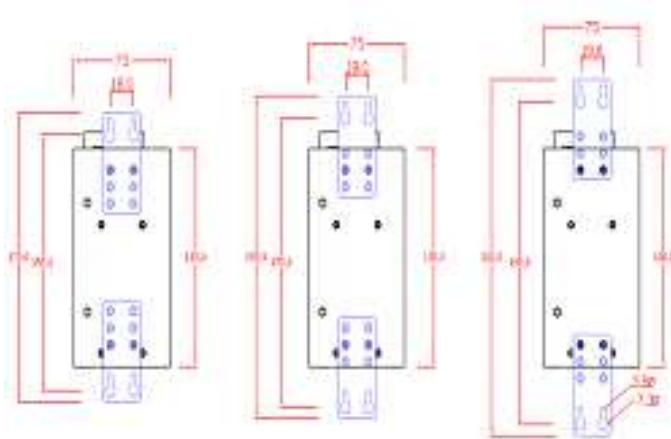

Appendix E - IDS Maintenance

- Ensure there is clearance of 50.8mm (2 inches) on all sides of the IDS switch to provide proper airflow through the unit
- Do not use solvents or cleaning agents on this unit
- Keep vent holes clear of debris
- If case gets dirty wipe with a dry cloth
- Ensure all cables are in good working condition
- Replace any frayed cables or cables without clips

Appendix F - Cables and Connectors

This appendix discusses the following topics:

- RJ45-Console Port Pinouts:
- Ethernet cables
- Ethernet Connector - 8 pin RJ45
- Fiber Port Cabling Requirements

RJ45-Console Port Pinouts

The console port uses a shield cable with an 8-pin female connector (with DTE pinouts).

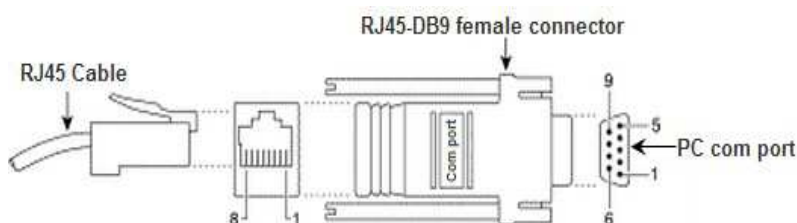

RJ-45 Console	Function	Direction
1	RTS	OUT
2	DTR	OUT
3	TXD	OUT
4	GND	-
5	GND	-
6	RXD	IN
7	DSR	IN
8	CTS	IN

Ethernet Cables

The 10/100/1000BaseT(X) ports located on the IDS switch's front panel are used to connect to Ethernet-enabled devices. These Ethernet ports will automatically adjust depending on the type of Ethernet cable used (straight-through or cross-over), and the type of device (NIC-type or HUB/Switch-type) connected to the port.

Requirements:

- Cat 5 UTP or STP, Cat 5e cables
- 24-22 AWG (0.20mm² - 0.33mm²)
- Straight through or Ethernet Crossover cable

Note: An optional cable adapter is available to provide RJ45 to DB9 conversion: Perle’s optional RJ45 to DB9-F crossover adapter model DB0020C enables a straight through Ethernet cable to connect the RJ45 console port to a PC serial port.

Fiber Cables

- Duplex SC or ST connector
 - Multimode 50/125 or 62.5/125 micron fiber cable
 - Single mode 9/125 micron fiber cable
- Simplex (BIDI, single strand) SC or ST connector
 - Multimode 50/125 or 62.5/125 micron fiber cable
 - Single mode 9/125 micron fiber cable

Ethernet Connector - 8-pin RJ-45

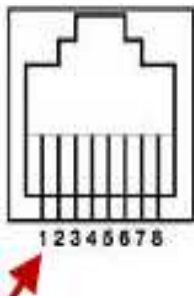

MDI Port Pinouts

Pin	Signal
1	Tx+
2	Tx-
3	Rx+
6	Rx-

MDI-X Port Pinouts

Pin	Signal
1	Rx+
2	Rx-
3	Tx+
6	Tx-

Fiber Connections

SC-port Pinouts

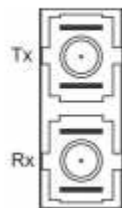

SC-Port to SC Port Cable Wiring



ST-Port Pinouts

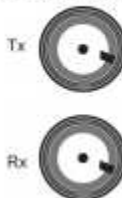

ST-Port to ST-Port Cable Wiring

