



Perle Gigabit Media Converters

Installation Guide

SR-1000-XXXXXX-(XT)

SR-1000-SFP-(XT)



Preface

Audience

This guide is for the network or computer technician responsible for installing the Perle SR-1000 Gigabit Media Converter. Familiarity with the concepts and terminology of Ethernet and local area networks is required.

Purpose

This document describes the hardware and physical characteristics of the Perle SR-1000 media converter. It covers hardware features as well as installation and operation of the SR-1000.

Package Contents

- SR-1000 Media Converter with attached DIN Rail mounting bracket
- Installation Guide (this guide)

Document Conventions

Note: *Means reader take note:* notes contain helpful suggestions.

Caution: Means reader be careful. In this situation, you might perform an action that could result in equipment damage or loss of data.

Warning: IMPORTANT SAFETY INSTRUCTIONS

Means danger. You are in a situation that could cause bodily injury. Before you work on any equipment, be aware of the hazards involved with electrical circuitry and be familiar with standard practices for preventing accidents. Only qualified personnel should connect power to this unit.



Warning - more information is contained within this guide



Warning - equipment rated above 40C. Equipment may be very hot.

Cautions and Warnings

Warning: Power sources must be off prior to beginning the power connection steps. Read the installation instructions before you connect the unit to its power source.

Warning: These devices are open-type devices that are to be installed in an enclosure with a tool removable cover or door, suitable for the environment.

Warning: Power supply of the equipment must be rated appropriately (See the Technical Specification section for specification with limited power). Limited power means complying with one of the following:

- Class 2 circuit according to Canadian Electrical Code, Part 1, C22.1
- Class 2 circuit according to National Electrical Code, NFPA-70
- Limited Power Supply (LPS) according to EN/IEC 60950-1.
- Limited-energy circuit according to EN/IEC 61010-1

Warning: If this equipment is used in a manner not specified by the manufacturer, the protection provided by the equipment may be impaired.

Warning: In case of malfunction or damage, no attempts at repair should be made by the user. All repairs need to be made by a qualified Perle representative. Do not dismantle this product.

Warning: Transient protection shall be provided that is set at a level not exceeding 140% of the peak rated voltage value at the supply terminals to the equipment.

Overview

This document contains instructions necessary for the installation and operation of the Perle Gigabit Industrial Ethernet Media Converters (SR-1000). These products convert a 1000Base-T cable connection (copper) to a 1000Base-X connection (fiber). The fiber connection can be either single mode (SM) or multimode (MM) and can operate over different wavelengths and distances, depending on the model selected (see table below). Perle Media Converters (SR-1000) are also available in Extended Temperature models.

Model	Connector	Mode - Distance	Wavelength
SR-1000-SC05 (XT)	SC	MM - 550 m/1804 ft.	850 nm
SR-1000-ST05 (XT)	ST	MM – 550m/1804 ft.	850 nm
SR-1000-SC05U	SC	MM – 550m/1804 ft.	1310/1550 nm
SR-1000-SC05D	SC	MM – 550m/1804 ft.	1550/1310 nm
SR-1000-SC2	SC	MM – 2 km/1.25 mi.	1310 nm
SR-1000-ST2	ST	MM – 2 km/1.25 mi.	1310 nm
SR-1000-SC10 (XT)	SC	SM – 10 km/6.2 mi.	1310 nm
SR-1000-ST10 (XT)	ST	SM –10 km/6.2 mi.	1310 nm
SR-1000-SC10U (XT)	SC	SM – 10 km/6.2 mi.	1310/1490 nm
SR-1000-SC10D (XT)	SC	SM – 10 km/6.2 mi.	1490/1310 nm
SR-1000-SC20U	SC	SM – 20 km/12.4 mi.	1310/1490 nm
SR-1000-SC20D	SC	SM – 20 km/12.4 mi.	1490/1310 nm
SR-1000-SC40	SC	SM – 40 km/25 mi.	1310 nm
SR-1000-ST40	ST	SM – 40 km/25 mi.	1310 nm
SR-1000-SC40U	SC	SM – 40 km/25 mi.	1310/1490 nm
SR-1000-ST40D	ST	SM – 40 km/25 mi.	1490/1310 nm
SR-1000-SC70	SC	SM – 70 km/40.3 mi.	1550 nm

SR-1000-ST70	ST	SM – 70 km/40.3 mi.	1550 nm
SR-1000-SC80U	SC	SM – 80 km/50 mi.	1550/1590 nm
SR-1000-SC80D	ST	SM – 80 km/50 mi.	1590/1550 nm
SR-1000-SC120	SC	SM – 120 km/74.6 mi.	1550 nm
SR-1000-ST120	ST	SM – 120 km/74.6 mi.	1550 nm
SR-1000-SC120U	SC	SM – 120 km/75 mi.	1510/1590 nm
SR-1000-SC120D	SC	SM – 120 km/75 mi.	1590/1510 nm
SR-1000-SC160	SC	SM – 160 km/100mi.	1550 nm
SR-1000-ST160	ST	SM – 160 km/100 mi.	1550 nm
SR-1000-SFP-(XT)	SFP	Note 1	

Note 1: Fiber characteristics will depend on the SFP fiber module selected

Note: Please visit Perle's web site for the most up to date Installation guides, models and specifications:

<http://www.perle.com/>

Installation

These are the steps required to configure the SR-1000 Gigabit media converter:

1. Insert SFP Module (SFP Model only).
2. Set the DIP switch settings. (optional)
3. Install and connect the fiber cable.
4. Install and connect the copper cable.
5. Power up the media converter.

The default DIP switch settings (all switches in the UP position) will work for most installations.

Accessing the DIP Switches

To access the DIP switches:

1. Disconnect the power source.
2. Release both tabs as located in the diagram (Step 1).
3. Gently slide the case open to expose the DIP switches (Step 2).
4. Slide the case open about 1/3 of the way until you hear an audible click. Do not force the case completely open.

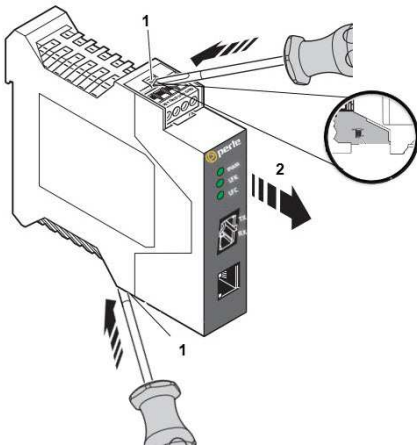

DIP Switches

Set the DIP Switches accordingly, and then slide the case together until you hear an audible click.

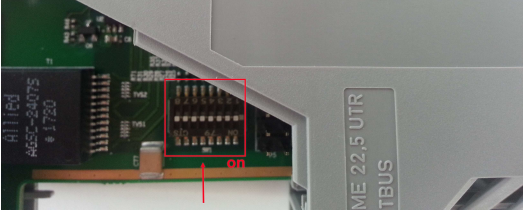

1	Reserved
2	Auto Negotiation
3	Smart Link Pass-Through
4	Fiber Fault Alert
5	Duplex Mode
6	Pause
7	Loopback
8	Reserved

DIP Switch Settings

Reserved (Switch 1)

Auto Negotiation (Switch 2)

Switch Position	Mode
Up (default)	On
Down	Off

On: In this mode of operation the media converter will negotiate Ethernet parameters on both the copper and the fiber connection. This will ensure the most optimal connection parameters will be in effect. If connecting to another Perle Gigabit Media Converter, this switch should be set to On.

Off: The Auto Negotiation should only be turned off, if the fiber link partner does not support fiber link negotiations.

When the Auto Negotiation switch is set to the Off position, the media converter will still negotiate the Ethernet parameters with the copper link partner. The parameters used in this negotiation by the media converter will be determined by the Duplex Mode (switch 5) and Pause (switch 6) switch settings.

Smart Link Pass-Through (Switch 3)

Switch Position	Mode
Up (default)	Disabled
Down	Enabled

Disabled: In this mode (if Auto Negotiation is set to Off), the links on the fiber and copper sides can be brought up and down independently of each other. A loss of link on either the fiber link or copper link can take place without affecting the other connection.

However, if the Auto Negotiation (switch 2) is set to On, then a loss of link on the copper side will result in a loss of link on the fiber side but not vice versa.

Enabled: In this mode, the link state on one connection is directly reflected through the media converter to the other connection. If

link is lost on one of the connections, then the other link will be brought down by the media converter.

If the installation has a media converter on both ends of the fiber link and both are setup for Smart Link Pass-Through, then a loss of copper link on the far end device will propagate through both media converters and will result in a loss of link at the near end device. This would, therefore, resemble a direct copper connection.

Fiber Fault Alert (Switch 4)

Switch Position	Mode
Up (default)	Enabled
Down	Disabled

Enabled: In this mode, if the media converter detects a loss of fiber signal on the fiber receiver, it will immediately disable its fiber transmitter signal. This, in effect, notifies the fiber link partner that an error condition exists on the fiber connection.

If the remote media converter is set up for Fiber Fault Alert (FFA) Enabled and the local media converter is set up with Smart Link Pass-Through, a loss of fiber link on either the transmit or receive line will be passed through to the local copper connection thus notifying the connected device.

If the media converter has been set to Smart Link Pass-Through mode, the effect will be the same as FFA, since the link loss on the fiber receiver will result in bringing down the copper link, which will in turn cause the transmit fiber link to be brought down.

Note: This feature only takes effect if Fiber Negotiation has been turned off.

Disabled: In this mode, the media converter will not monitor for fiber fault.

The following diagram is an illustration of the operation of this feature.

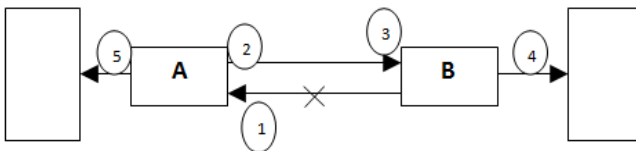

(A) – Remote Media Converter setup for Fiber Fault Alert Enabled, Fiber Negotiation – OFF and Link Mode – Normal.

(B) – Local Media Converter setup for Smart Link Pass-Through and Fiber Negotiation - OFF

(A) loses fiber connection on its receiver

(A) disables fiber transmitter

(B) detects loss of link in its fiber receiver

(B) drops link on copper connection through Smart Link Pass-Through

(A) Link on copper connection is not affected

Duplex Mode (Switch 5)

Switch Position	Mode
Up (default)	Auto
Down	Half

Auto: In this mode, when Auto Negotiation has been turned off (SW 2), the media converter will use this Duplex setting for its Ethernet parameter negotiation on the copper connection. In the Auto position, the media converter will advertise support for both Full and Half Duplex mode. The resultant negotiation will provide the most optimum connection.

Half: In this mode, the media converter will force the negotiation to Half Duplex mode.

Note: The Duplex parameter has no direct effect on the operation of the media converter. These are provided so that the attached device (near end) can negotiate its Ethernet parameters as if it was negotiating directly with the far end device. These parameters on the media converter should match those of the far end device.

Pause (Switch 6)

Switch Position	Mode
Up (default)	Enabled
Down	Disabled

Enabled: In this mode, when Auto Negotiation has been turned Off (SW 2), the media converter will use this setting for its Ethernet parameter negotiation on the copper connection. With this Pause

switch in the Enabled position, the media converter will advertise support for Symmetrical and Asymmetrical Pause.

Disable: The media converter will not advertise support for the Pause feature.

Note: The media converter will not act on, or generate any Pause Ethernet messages, but will pass them through to the end device. This switch setting is provided so that the attached device (near end) can negotiate its Ethernet parameters as if it was negotiating directly with the far end device. The Pause switch setting on the media converter should match the capabilities of the far end device.

Loopback (Switch 7)

Switch Position	Mode
Up (default)	Disabled
Down	Enabled

Disabled: The loopback feature is disabled. This is the normal position for regular operation. The switch must be set to this position for data to pass through the media converter.

Enabled: When enabled, all data received on the receive (RX) fiber connection is looped back to the transmit (TX) fiber connection. The state of the copper is not relevant and no data or link status is passed through to the copper side.

Reserved (Switch 8)

Installing the SFP Fiber Module

The SR-1000-SFP requires an SFP fiber module.

1. Locate your fiber module, and then insert the module into the transceiver opening.
2. Ensure the SFP module is properly seated.
3. The SFP module may be inserted before or after applying power to the media converter.
4. Proceed with cable connections.

Installing the Duplex Fiber Cable

- Locate a 1000Base-X compliant duplex (2 strands) fiber cable with male connections.
- Connect the fiber cables from one media converter to the other media converter/switch/fiber device ensuring that the RX and TX are reversed at the opposite end.

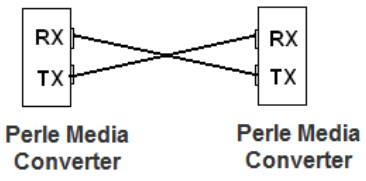

Installing the Simplex Fiber Cable

Locate a 1000Base-X compliant simplex (1 strand) fiber cable with male connections.

- Connect the fiber cable from one media converter to the other media converter/switch/fiber device.

Installing the Copper Cable

- Locate 1000Base-TX compliant copper cables with male, RJ45 connectors installed at both ends.
- Connect the RJ-45 cable between the Perle media converter and the device.

Note: The Perle media converter supports Auto-MDI-X, either a straight-through or cross over Ethernet cable may be used.

Connecting the Terminal Block

The terminal block provides two power inputs. Both power inputs can be connected to the SR-1000 to provide redundant power to the SR-1000. If one power supply should fail the SR-1000 will use the other power supply to continue to power the unit without interruption. Wiring with suitable temperature ratings must be used. Use copper conductors only.

1. Ensure the power source is off prior to connection.
2. Strip both (12-20AWG) wires 7-8 mm(5/16th).
3. Loosen the terminal block screws and connect positive (+)/negative (-) wires into the +/- terminals.
4. Tighten terminal screws (0.5Nm torque). Ensure the wires are securely fastened.
5. If desired, connect P2 (power source 2, beginning at Step 1)
6. Turn on the power at source.
7. Check that the PWR LED light is lit.
8. Check LED indicators in the guide before and applying power to the media converter.
9. Ensure that there is one individual conductor for each clamping point.



Operation

Status LED

The SR-1000 Gigabit Media converters have three status LEDs located on the front panel of the unit.

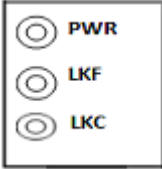

PWR - Power/Test

- **On:** Power is on and the unit is in normal operation mode.
- **Blinking quickly:** the unit is in loopback mode.
- **Blinking slowly:** the unit has a hardware error.

LKF - Fiber Link/Activity

- **On:** Fiber link present.
- **Blinking quickly:** Fiber link present and receiving data.
- **Blinking slowly:** Fiber link disabled because of copper link loss.
- **Off:** No fiber link present.

LKC - Copper Link/Activity

- **On:** Copper link is present.
- **Blinking quickly:** Copper link present and receiving data.
- **Blinking slowly:** Copper link disabled because of fiber link loss.
- **Off:** No copper link present.

Other Features

Default Operating Mode:

In the default operating mode (all switches up), the media converter will auto-negotiate on both the fiber and the copper links at the same time, thus achieving the best end-to-end Ethernet operating parameters. If the fiber link is not present, it will still permit the copper link to be established, but will not negotiate a fiber link if the copper link is not present. Therefore, the device attached to the media converter will not see a loss of link if the fiber connection is lost.

Auto-MDI-X with Skew Correction:

Auto-MDI-X (automatic medium-dependant interface crossover) detects the signalling on the 1000BASE-T interface to determine the type of cable connected (straight-through or crossover) and automatically configures the connection. The media converter can also correct for wires swapped within a pair.

Error Recovery:

In certain configurations, and under specific conditions where the media converter brings down a link to convey status, there is potential for a deadlock. Recovery is achieved by momentarily restoring the link to see if the original failure has been resolved. If it has not, the link will be forced down again, however if the original problem has been resolved, the link will be restored.

Example: If two converters are setup for FFA. The detection of a fiber link failure (RX) will cause one media converter to disable its fiber transmitter (TX). This in turn will cause the other to do the same, and a deadlock condition has been created. The media converter will periodically turn on its transmitter (TX) to re-start the link and see if the original failure has been resolved. If not, the TX is once again turned off.

Troubleshooting

General

- Ensure power is supplied to the media converter.
- Ensure both devices on either end of the fiber are compatible. If using a single fiber connection, ensure that you have both an Upstream (U) and Downstream (D) media converter.
- Ensure all cabling is of the correct type and is in good operating condition.
- For dual-stranded fiber connections, ensure the RX and TX has been reversed between the 2 media converters.

No connectivity

If unable to get full connectivity with all DIP switches in the UP position, this procedure is recommended for troubleshooting.

Method 1

1. Turn off Fiber Negotiation (SW2 Down) on both media converters. Leave all other switches UP.
2. Connect the near end device to the copper connection. The LKC LED indicates good copper connection. If the LKC LED is not lit, then check the copper cable and the attached device.
3. Repeat for the far end device.
4. Connect the fiber cable to both media converters. The LKF LED indicates good fiber connection. If no LKF LED then check the fiber cabling.
5. Return units to desired configuration.

Method 2:

The fiber connection can also be verified by configuring the remote media converter for loopback mode. The LKF LEDs on both media converters should be lit. Data should pass through the local converter, over the fiber connection to the remote media converter. At the remote media converter, the data will be looped back and passed through the fiber, once again, to pass through the local converter to the copper link.

Technical Specifications

The following applies to all SR-1000 media converters.

Input Supply Voltage	9.6-60VDC 0.4A max, unregulated (12/24/48-VDC nominal)
Power Consumption	2.4 watts
Operating Temperature	-10°C - 60°C (14°F - 140°F)
Storage Temperature:	-40°C - 85°C (-40°F - 185°F)
Operating Temperature (XT)	-40°C - 75°C (-40°F -167°F)
Storage Temperature (XT)	-40°C - 85°C (-40°F -185°F)
Operating Humidity:	5% to 90% non-condensing
Storage Humidity:	5% to 95% non-condensing
Operating Altitude:	Up to 3,048 m (10,000 ft.)
Weight:	0.12kg
Dimensions SC	114 x 100 x 22.5 mm
ST	126 x 100 x 22.5 mm
SFP	117 x 100 x 22.5 mm
Safety	
UL/ULC/EN 62368-1 CAN/CSA C22.2 No. 62368-1-14 UL 61010-1 and UL 61010-2-201 Laser Class I Safety – IEC 60825-1:2014 IEC-60825-1:2014 standard and complies with FDA/CDRH 21 CFR1040.10 and 21 CFR1040.11	
EMI/EMC	
FCC 47 Part 15 Class A ICES-003 EN55032(CISPR32) EN61000-6-4 EN55024 IEC/EN 61000-6-2 General Immunity for Industrial Environments IEC/EN 61000-4-2 (ESD): Contact: EN 61000-4-3 (RS) EN 61000-4-4 (EFT) EN 61000-4-5 (Surge) EN 61000-4-6 (CS) EN 61000-4-8 (PFMF) EN 61000-4-11	

Fiber Optic Specifications

The following table applies to all SR-1000 media converters.

Model	Mode	Wavelength (nm)	TX Power (dB)	RX Power (dB)	Budget (dB)
SR-1000-SC05 (XT)	MM	TX: 850 RX: 850	Min: -9.5 Max: -4	Min: -17 Max: -3	7.5
SR-1000-ST05 (XT)	MM	TX: 850 RX: 850	Min: -9.5 Max: -4	Min: -17 Max: -3	7.5
SR-1000-SC05U	MM	TX: 850 RX: 850	Min: -9.5 Max: -4	Min: -17 Max: -3	7.5
SR-1000-SC05D	MM	TX: 850 RX: 850	Min: -9.5 Max: -4	Min: -17 Max: -3	7.5
SR-1000-SC2	MM	TX: 1310 RX: 1310	Min: -6 Max: 0	Min: -17 Max: 0	11
SR-1000-ST2	MM	TX: 1310 RX: 1310	Min: -6 Max: 0	Min: -17 Max: 0	11
SR-1000-SC10 (XT)	SM	TX: 1310 RX: 1310	Min: -9.5 Max: -3	Min: -20 Max: -3	10.5
SR-1000-ST10 (XT)	SM	TX: 1310 RX: 1310	Min: -9.5 Max: -3	Min: -20 Max: -3	10.5
SR-1000-SC10U (XT)	SM	TX: 1310 RX: 1490	Min: -9 Max: -3	Min: 20 Max: -3	11
SR-1000-ST10D (XT)	SM	TX: 1310 RX: 1310	Min: -9 Max: -3	Min: -20 Max: -3	11
SR-1000-SC20U	SM	TX: 1310 RX: 1490	Min: -8 Max: -3	Min: -22 Max: -3	11
SR-1000-ST20D	SM	TX: 1310 RX: 1490	Min: -8 Max: -3	Min: -22 Max: -3	11
SR-1000-SC40	SM	TX: 1310 RX: 1310	Min: -3 Max: 5	Min: -23 Max: -3	20
SR-1000-ST40	SM	TX: 1310 RX: 1490	Min: -3 Max: 2	Min: -23 Max: -3	20
SR-1000-SC40U	SM	TX: 1310 RX: 1490	Min: -3 Max: 2	Min: -23 Max: -3	20
SR-1000-SC40D	SM	TX: 1490 RX: 1310	Min: -3 Max: 2	Min: -23 Max: -3	20
SR-1000-SC70	SM	TX: 1550 RX: 1550	Min: 0 Max: 5	Min: -23 Max: -3	23
SR-1000-ST70	SM	TX: 1550 RX: 1550	Min: 0 Max: 5	Min: -23 Max: -3	23

Model	Mode	Wavelength (nm)	TX Power (dB)	RX Power (dB)	Budget (dB)
SR-1000-SC80U	SM	TX: 1510 RX: 1590	Min: -2 Max: 3	Min: -26 Max: -3	24
SR-1000-SC80D	SM	TX: 1590 RX: 1510	Min: -2 Max: 3	Min: -26 Max: -3	24
SR-1000-SC120	SM	TX: 1550 RX: 1550	Min: 0 Max: 5	Min: -32 Max: -9	32
SR-1000-ST120	SM	TX: 1550 RX: 1550	Min: 0 Max: 5	Min: -32 Max: -9	32
SR-1000-SC120U	SM	TX: 1510 RX: 1590	Min: -3 Max: 2	Min: -34 Max: -9	31
SR-1000-SC120D	SM	TX: 1590 RX: 1510	Min: -3 Max: 2	Min: -34 Max: -9	31
SR-1000-SC160	SM	TX: 1550 RX: 1550	Min: 2 Max: 5	Min: -34 Max: -9	32
SR-1000-ST160	SM	TX: 1550 RX: 1550	Min: 2 Max: 5	Min: -34 Max: -9	32

Fiber Cabling Requirements:

MM: 50/125 microns or 62.5/125 microns

SM: 9/125 microns

Ethernet Copper Cabling Requirements

- Category 5e UTP or STP
- Straight through or Ethernet crossover

Note: Please refer the product page on the Perle website for the most up to date specifications.

<http://www.perle.com/>

Mechanical Drawings

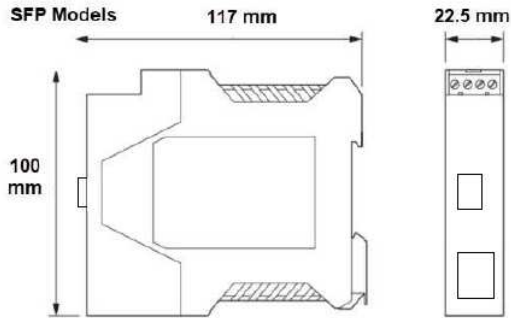
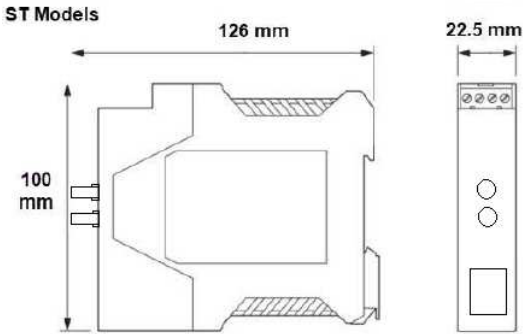
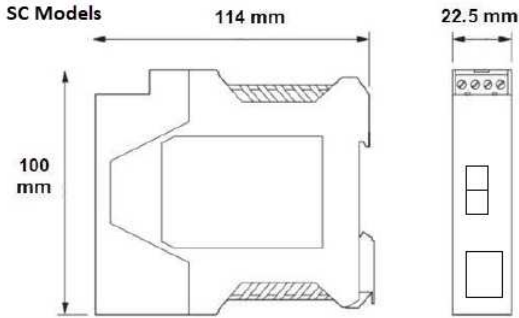

Connecting the SR-1000 to a DIN Rail

The DIN Rail clip will be attached to the SR-1000.

Mounting the SR-1000 on a DIN Rail

1. Position the SR-1000 so that the top hooks of the DIN Rail clip attach onto the top of the DIN Rail.
2. Rotate the bottom of the SR-1000 towards the rail. This will snap the bottom hooks of the DIN Rail clip onto the bottom of the DIN Rail.



Removing the SR-1000 from the DIN Rail

The DIN Rail attachment clip has a slot at the bottom of the latch that is visible beneath the SR-1000 when it is mounted.

1. Insert a flat blade screwdriver into the slot and twist the base to release the clip. Alternatively, a downward force on the clip will release the clip.
2. When the clip is released, pull the bottom of the SR-1000 out slightly and remove the SR-1000 from the DIN Rail.



Connecting the SR-1000 to a TBUS

An optional TBUS-5-22.5-BK connector can be purchased for the SR-1000. See <http://www.perle.com/> for more information.

The DIN Rail connector is an alternative method of connecting a power supply.

1. Install the TBUS connectors onto the DIN Rail.
2. Snap them together (as shown in the diagram) to create an electrical connection.
3. Install the media converter onto the DIN Rail overtop one of the TBUS connections, ensuring that the TBUS extension connects into the media converters TBUS slot.
4. Repeat the procedure for the power supply.

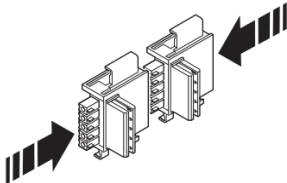

Warranty / Registration

Details can be found at:

http://www.perle.com/support_services/warranty.shtml

Contacting Technical Support

Contact information for the Perle Technical Assistance Center (PTAC) can be found at the link below. A Technical Support Query may be made via this web page.

www.perle.com/support_services/support_request.shtml

Sample Labels

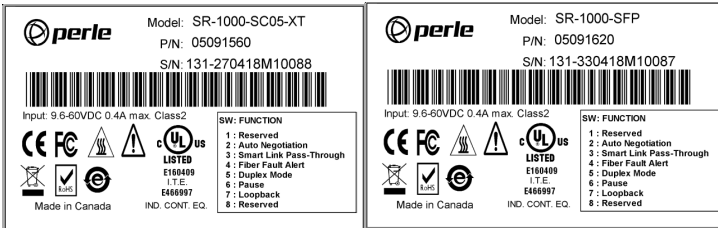

THE SPECIFICATIONS AND INFORMATION REGARDING THE PRODUCTS IN THIS GUIDE ARE SUBJECT TO CHANGE WITHOUT NOTICE. ALL STATEMENTS, INFORMATION, AND RECOMMENDATIONS IN THIS GUIDE ARE BELIEVED TO BE ACCURATE BUT ARE PRESENTED WITHOUT WARRANTY OF ANY KIND, EXPRESS OR IMPLIED. USERS MUST TAKE FULL RESPONSIBILITY FOR THEIR APPLICATION OF ANY PRODUCTS.

This equipment has been tested and found to comply with the limits for a Class A digital device, pursuant to part 15 of the FCC rules. These limits are designed to provide reasonable protection against harmful interference when the equipment is operated in a commercial environment. This equipment generates, uses, and can radiate radio-frequency energy and, if not installed and used in accordance with this hardware guide may cause harmful interference to radio communications. Operation of this equipment in a residential area is likely to cause harmful interference, in which case users will be required to correct the interference at their own expense.

Modifications to this product not authorized by Perle could void the FCC approval and negate your authority to operate the product.

























Perle reserves the right to make changes without further notice, to any products to improve reliability, function, or design.

Perle, the Perle logo, and SR-1000 Media Converters are trademarks of Perle Systems Limited.

Copyright
©2018 Perle Systems Limited.

60 Renfrew Drive
Markham, Ontario
L3R 0E1 Canada

All rights reserved. No part of this document may be reproduced or used in any form without written permission from Perle Systems.

 Model: SR-1000-SC05-XT P/N: 05091560 S/N: 131-270418M10088  Input: 9.6-60VDC 0.4A max. Class2           Made in Canada IND. CONT. EQ.	SW: FUNCTION 1 : Reserved 2 : Auto Negotiation 3 : Smart Link Pass-Through 4 : Fiber Fault Alert 5 : Duplex Mode 6 : Pause 7 : Loopback 8 : Reserved
 Model: SR-1000-SFP P/N: 05091620 S/N: 131-330418M10087  Input: 9.6-60VDC 0.4A max. Class2           Made in Canada IND. CONT. EQ.	SW: FUNCTION 1 : Reserved 2 : Auto Negotiation 3 : Smart Link Pass-Through 4 : Fiber Fault Alert 5 : Duplex Mode 6 : Pause 7 : Loopback 8 : Reserved