

TRNC[G]-7-60

- Standard four hole rail fixing
- Wideband LTE/Celular/WIFI element
- Optional Integrated GPS / GNSS / antenna [TRNCG version]
- Suitable for GSM-R rail applications

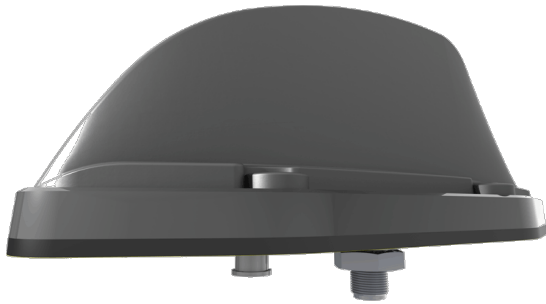

The TRNC(G) antenna series has been designed specifically for use on trains, trams and buses underground or over ground.

The TRNC(G)-7-60 range covers 698-960/1710-6000MHz with optional GPS/GNSS with a 26dB LNA. The radiating element is DC grounded and, in versions with a GPS module it is protected by a gas discharge surge arrester.

Housed in a high impact, flame retardant Ultem housing, the TRNC(G) series is weatherproof ensuring that the antenna's performance is never compromised.

The TRNC[G]-7-60 meets stringent industry standards including EN50155, EN45545-2 (HLI-3), EN50124 (40 KA 100 MS) and is ingress protected to IP69K when properly installed.

Technical Drawing

TRNCG-7-60 shown

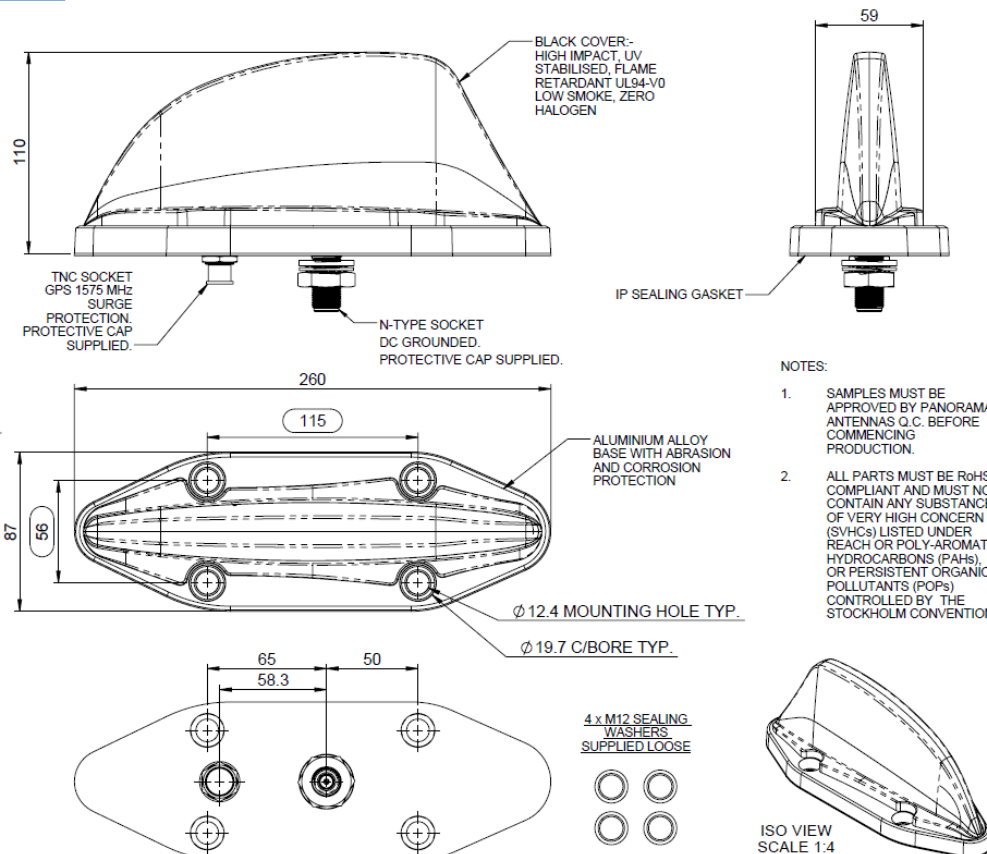

Product Data

Part No.		TRNCG-7-60	TRNC-7-60
Frequency Range (MHz)		698-960/1710-6000 MHz	
Peak Gain: **	698-960MHz	5dBi	
	1710-2700MHz	7dBi	
	4900-6000MHz	10dBi	
Polarisation		Vertical	
Typical VSWR*		< 2.5:1	
Pattern		Omni-directional	
Impedance		50Ω	
Max Input Power (W)		60	
GPS Data			
Frequency Range (MHz)		1560-1612	-
Impedance		50Ω	-
LNA Gain		26dB ± 3	-
Polarisation		Righth Hand Circular	-
Operating Voltage		3-5V DC	-
Current (Typical)		15mA	-
GPS Antenna EMC Compliance		EN 301 489-1 V1.81 & EN 301 489-3 V1.6.1 EN 50121-3-2:2015	-
Mechanical Data			
Dimensions (mm)	Height (N/inc pad)	110 (4.33")	
	Width	87 (3.42")	
	Length	260 (10.23")	
Environmental Specification			
Operating Temp (°C)		-40° / +80°C (-40° / +176°F)	
Radome Material		Ultem 1000	
Radome Flame Retardance Rating		V0 (UL 94)	
Base Material		Cast Aluminium	
Ingress Protection		IP67 (Report No. 98883) or IP69K when installed in accordance with SW3 - 988 (Report No. 103439)	
Approvals Data			
Regulatory Approvals		EN50155:2007 (Dry heat & Cooling), EN61373:2010 / EN50155:2007 (Shock & Vibration), EN45545 - HL3 (flammability) / EN50124-1:2017 (40 KA 100 MS)	
Mounting Data			
Fixing		4 × mounting holes to suit M12 bolts	
Termination Data			
Termination	Comms	N (female) - DC grounded	
	GPS	TNC (female) - surge protected	-

** Simulated on a 600 x 600mm (2' x 2') ground plane without cable.

* Measured on a 600 x 600mm (2' x 2') ground plane with 1m (3') of low loss cable

Electrical Data

Typical VSWR*

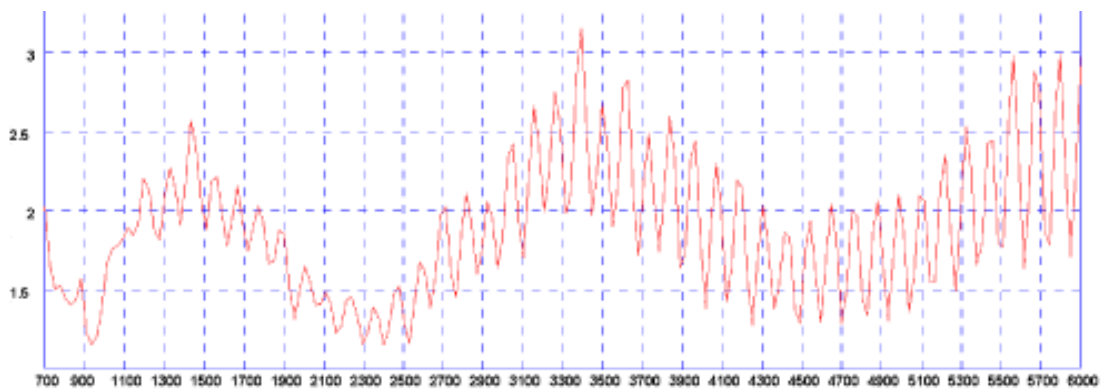

* Measured on a 600 x 600mm (2' x 2') ground plane with 1m (3') of low loss cable

Typical H Plane - 700MHz

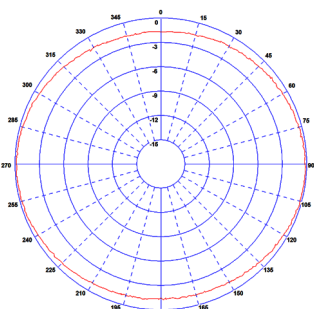

Typical H Plane - 800MHz

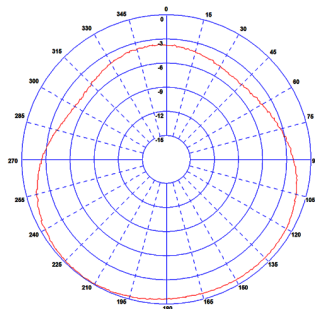

Typical H Plane - 900MHz

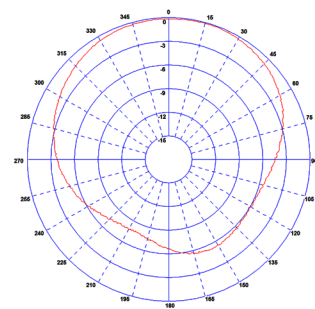

Typical H Plane - 1800MHz

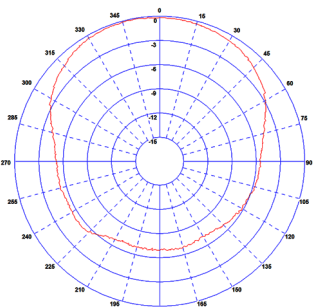

Typical H Plane - 2100MHz

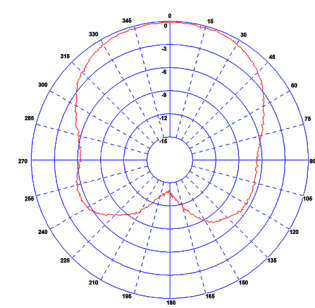

Typical E-Plane Pattern - (GPS) 1575MHz

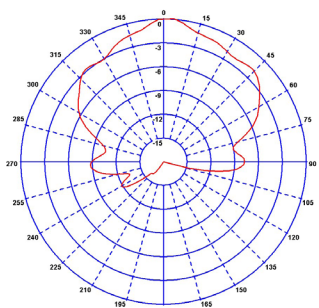

Patterns measured on a 600 x 600 (2' x 2') ground plane with 1m (3') of low loss cable