

LGE-7-27-24-58

Low Profile LTE, WiFi & GPS

22/09/2015 v.1

Low Profile 2G/3G/4G Antenna With WiFi And GPS

Rugged Low Profile Design

Wideband LTE-Cellular Element

2.4 & 4.9-6GHz WiFi Element

Integrated GPS/GNSS/BEIDOU antenna



The LG[P]E antenna series is a range of low profile antennas incorporating a combination of wideband cellular elements covering 2G/3G and 4G frequencies along with an active GPS patch with 26dB LNA gain and a dual band WiFi element in a robust compact housing.

Designed to be tough yet cost effective, the antennas are completely enclosed in a moulded housing made from weather and impact resistant plastic. The range is supplied with short fly leads and can be kitted with Panorama Antennas' low loss extension cables in various lengths.

Ground Plane Independent

This antenna does not require a ground plane, and maintains a high level of performance even when mounted on a non-metallic surface.

Technical Drawing

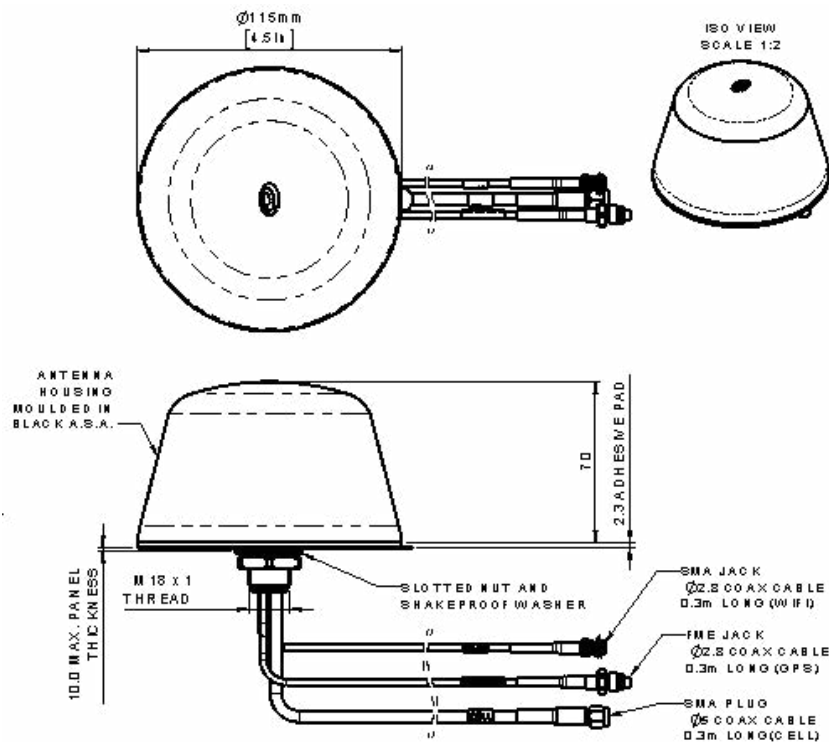

PANORAMA ANTENNAS
Panorama Antennas Ltd
Frogmore, London, SW18 1HF, United Kingdom

T: +44 (0)20 8877 4444
F: +44 (0)20 8877 4477
E: sales@panorama-antennas.com
www.panorama-antennas.com

Waiver: The data given above is indicative of the performance of the product/s under particular conditions and does not imply a guarantee of performance. These specifications are subject to change without notice.

Copyright © Panorama Antennas Ltd. All rights reserved.

Part No.		LGE 7-27-24-58
Electrical Data		
Frequency Range (MHz)	Element 1	1560-1612
	Element 2	698-960 / 1700-2700
	Element 3	2.4/ 4.9-6GHz
Operational Bands	Element 1	GPS / GNSS / BEIDOU
	Element 2	LTE / Cellular
	Element 3	WIFI / 802.11 a/b/g/n
Peak Gain: Isotropic	Element 2	698-960MHz 4dBi
		1710-2700MHz 6dBi
	Element 3	2dBi
Typical VSWR	Element 2	≤ 2.5:1
	Element 3	≤ 2.5:1
Polarisation	Vertical	
Impedance	50Ω	
Max Input Power (W)	50	
GPS Data		
Frequency Range (MHz)	1560-1612	
VSWR	<2.0:1 ± 4MHz	
Gain: LNA	26dB	
Polarisation	Right Hand Circular	
Operating Voltage	3 -5V DC (fed via coax)	
Current	Typical 15mA	
Mechanical Data		
Dimensions	Height	2.8" (70mm)
	Diameter	4.5" (115mm)
Operating Temp	-22° / 176°F (-30° / +80°C)	
Material	A.S.A	
Colour	Black	
Mounting Data		
Mounting type	Panel mount	
Max panel thickness	0.4"(10mm)	
Mounting hole	3/4" (19mm)	
Cable Data		
GPS Cable	Type	RG174
	Diameter	0.11" (2.8mm)
	Length	1' (0.3m)
	Termination	FME (female)
Cell / LTE Cable	Type	CS29 (double shielded RG58)
	Diameter	0.2"(5mm)
	Length	1' (0.3m)
	Termination	SMA (male)
WIFI / WiMAX Cable	Type	RG174
	Diameter	0.1" (2.8mm)
	Length	1' (0.3m)
	Termination	SMA (female)

We recommend the customer uses Panorama CS29 extension cables for 2G/3G/4G, CS32 extension cables for WLAN and RG174 or CS23 for GPS.

Typical VSWR cellular / LTE element 2*

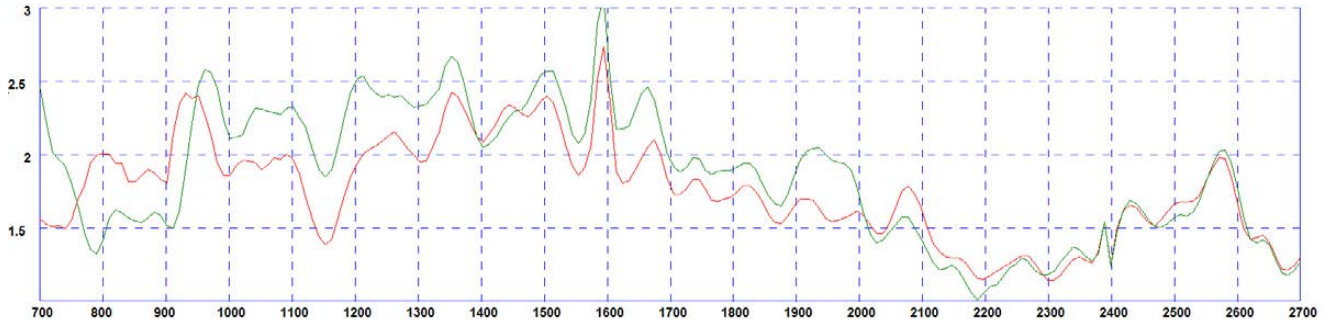

* Red VSWR measured in on a 400 x400mm (1.3' x 1.3') ground plane without extension cables.
Green VSWR measured in free space without extension cables.

Typical VSWR WLAN element 3 - 5.8GHz*

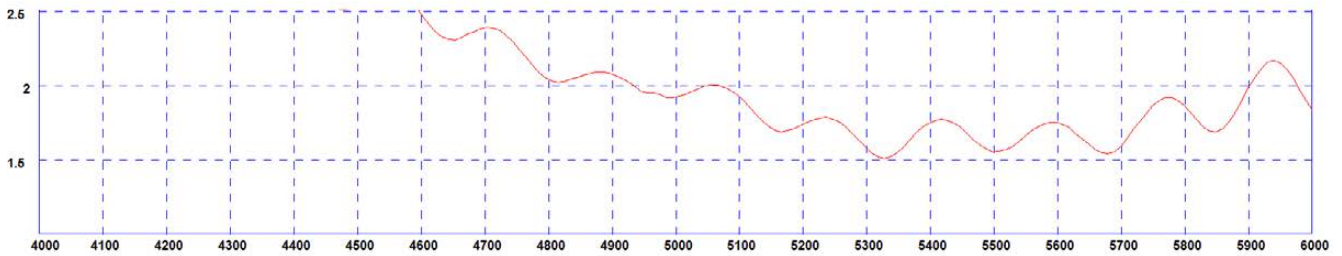

* VSWR measured with 0.5m (1.5') of RG174 cable.

Typical VSWR WLAN element 3 - 2.4GHz*

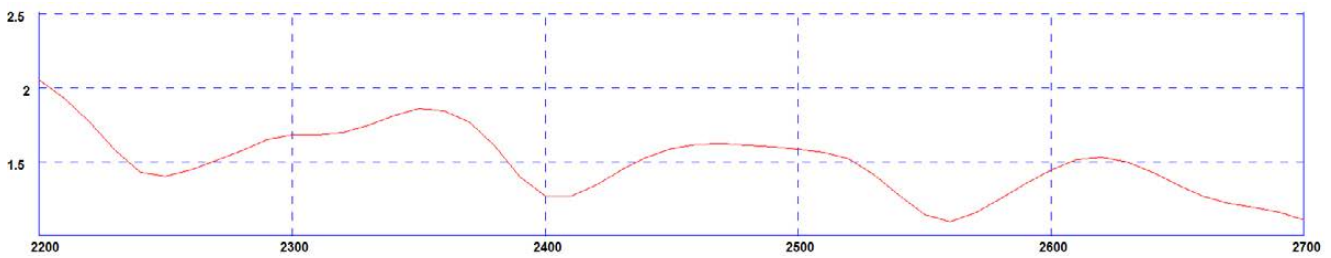

* VSWR measured with 0.5m (1.5') of RG174 cable.

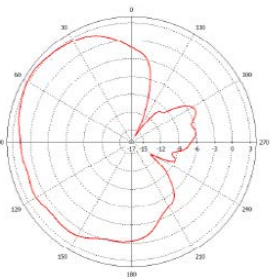

H-Plane - WLAN (2.4GHz)

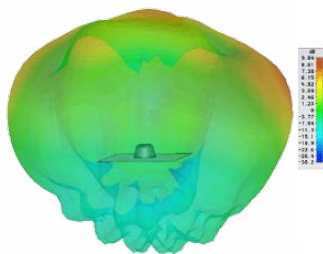

3D Pattern - WLAN (2.4GHz)

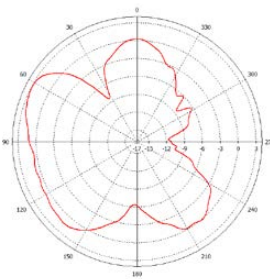

H-Plane WLAN (5.4GHz)

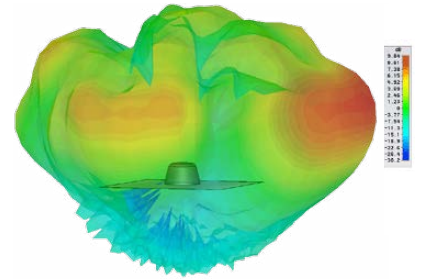

3D Pattern WLAN (5.4GHz)

Typical 3D Pattern - Element 2 700MHz

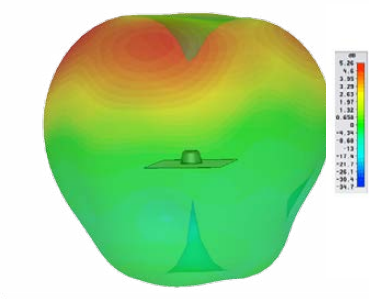

Typical 3D Pattern - Element 2 800MHz

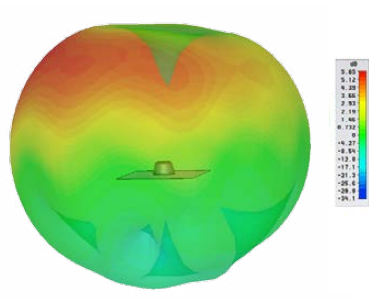

Typical 3D Pattern - Element 2 900MHz

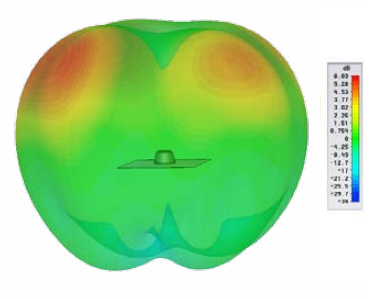

Typical 3D Pattern - Element 2 1800MHz

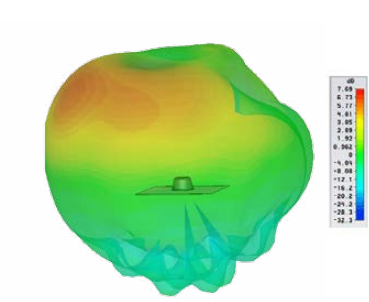

Typical 3D Pattern - Element 2 2000MHz

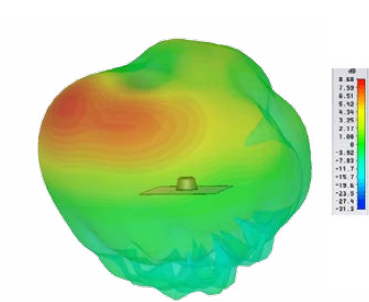

Typical 3D Pattern - Element 2 2600MHz

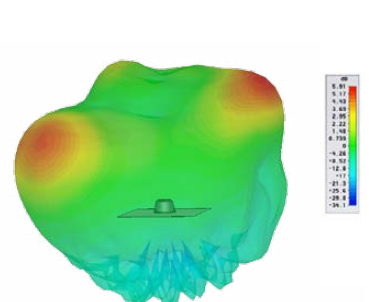

Typical H-Plane (700MHz)

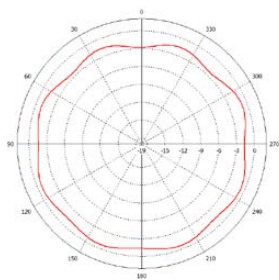

Typical H-Plane (800MHz)

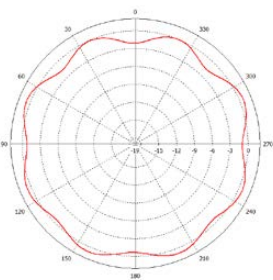

Typical H-Plane (900MHz)

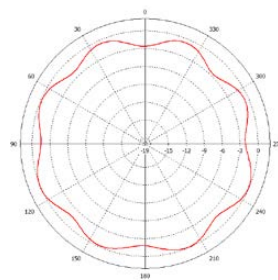

Typical H-Plane (1.7GHz)

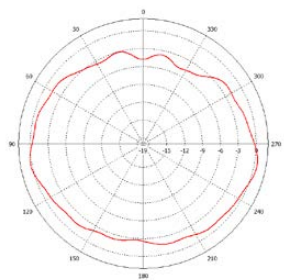

Typical H-Plane (1.9GHz)

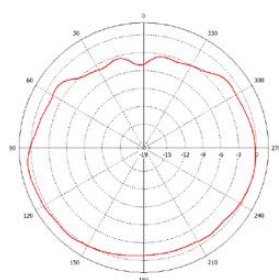

Typical H-Plane (2.7GHz)

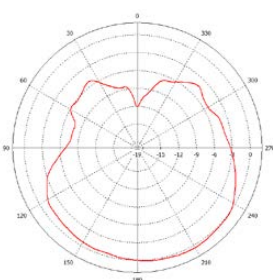

| All pattern and gain measurements taken on a 400 x 400mm (2' x 2') ground plane without additional cable.

Panorama Antennas Ltd
Frogmore, London, SW18 1HF, United Kingdom

T: +44 (0)20 8877 4444
F: +44 (0)20 8877 4477

E: sales@panorama-antennas.com
www.panorama-antennas.com

Waiver: The data given above is indicative of the performance of the product/s under particular conditions and does not imply a guarantee of performance. These specifications are subject to change without notice.
Copyright © Panorama Antennas Ltd. All rights reserved.

PANORAMA  *ANTENNAS*