

Monitor Module with VGA/ HDMI/ DP inputs



FEATURES

- 1x VGA, 1x DisplayPort, 1x HDMI
- 1x USB 2.0, 1x COM, 1x Audio
- 9 to 48VDC wide range power input
- -10°C to 60°C extended operating temperature

Display

VGA	1x VGA Input
HDMI	1x HDMI Input
DisplayPort	1x DisplayPort Input
USB 2.0	1x USB 2.0 Input
COM Port	1x COM Port Input (Resistive Touch Only)
Audio	1x Audio Input

Power

Power Supply Voltage	9-48VDC
Power Connector	3-pin Terminal Block
Power Adaptor	Optional AC/DC 12V/5A, 60W
Power Protection	OVP (Over Voltage Protection) OCP (Over Current Protection) Reverse Protection

Environment

Operating Temp.	-10°C to 60°C
Storage Temp.	-20°C to 70°C
Relative Humidity	10%-80% (non-condensing)
Vibration	5 Grms, 5 - 500 Hz, 0.5 hr/axis
Shock	50G, half sine, 11ms
Standards / Certification	CE, FCC Class A

Physical

Construction	Extruded Aluminum with Heavy Duty Metal
Dimension	246 (W) x 220 (D) x 37 (H)mm
Weight	1.61 kg
Mounting	VESA Mounting Holes 75 x 75mm, 100 x 100mm

DIMENSION

Unit: mm

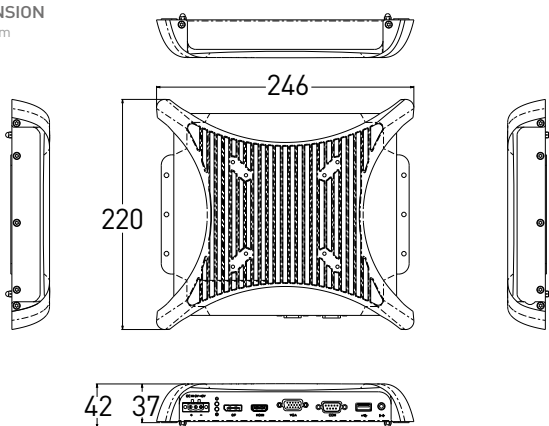

EXTERNAL I/O MECHANICAL LAYOUT

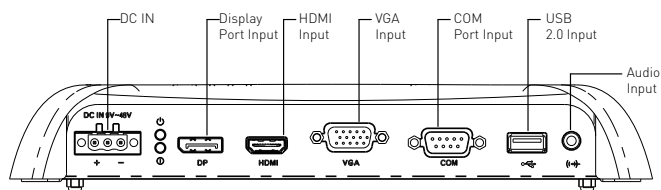

ORDERING INFORMATION

MODEL NO.	DESCRIPTION
1-E09A06008	Adapter AC/DC 12V 5A 60W with 3pin Terminal Block Plug 5.0mm Pitch
SFICBL022	Power Cord, 3-pin US Type, 180cm
1-TPCD00002	Power Cord, European Type, 180cm
1-TPCD00001	Power Cord, 3-pin UK Type, 180cm

PACKING LIST

• 1x MX200 Series Monitor Module
• 1x USB Cable
• 1x VGA Cable
• 1x Screw Pack

AVAILABLE MODELS

MODEL NO.	DESCRIPTION
MX200	Monitor Module with 1x VGA Input, 1x HDMI Input, 1x DP Input, 1x USB 2.0 Input