



MACHINE VISION COMPUTER

# VCO-6000-CFL-2-2PWR

Machine Vision Computer with 9th Gen Intel® Core™ CFL-R S Processor, 2x Expansion, Dual Power Input



## Features

- Support 9th Gen Intel® CFL-R S Processor (LGA 1151, 35W TDP)
- Intel® Q370 Chipset
- Triple Independent Display by 1x DVI-I and 2x DisplayPort
- 2x Intel® GbE supporting Wake-on-LAN and PXE
- 2x Full-size mini PCIe (shared by 1x mSATA), and 2x SIM socket
- 4x 2.5" SATA HDD Bay with RAID 0, 1, 5, 10 support, 1x mSATA (Shared by 1x Mini PCIe)
- 1x M.2 (M Key, NVMe PCIe x4, 2280), 1x M.2 (E Key, PCIe x2, USB 2.0, 2230, Support CNVi)
- 6x RS-232/422/485 (4x internal)
- 4x USB 3.2 Gen 2 (10 Gbps), 4x USB 3.2 Gen 1 (5 Gbps, internal)
- 8x DI + 8x DO with isolation
- 9 to 48V DC Wide Range Power Input Supporting AT/ATX Mode
- Wide Operating Temperature (-25°C to 70°C)
- TPM 2.0 Supported



## Specifications

### System

Processor	Support 9th Gen Intel® Core™ CFL-R S Processor (LGA 1151, 35W TDP) - Intel® Core™ i7-9700TE, 8 Cores, 12MB cache, up to 3.8 GHz - Intel® Core™ i5-9500TE, 6 Cores, 9MB Cache, up to 3.6 GHz - Intel® Core™ i3-9100TE, 4 Core, 6MB Cache, 3.2 GHz
System Chipset	Intel® Q370 Express Chipset
LAN Chipset	GbE1: Intel I219LM (Support Wake-on-LAN and PXE) GbE2: Intel I210-AT (Support Wake-on-LAN and PXE)
Audio Codec	Realtek ALC888S
System Memory	2x 260-Pin DDR4 2400/2666MHz SODIMM. Max. up to 64GB
Graphics	Intel® UHD Graphics 610/630
BIOS	AMI 256Mbit SPI BIOS
Watchdog	Software Programmable Supports 1~255 sec. System Reset
TPM	TPM 2.0

### Display

Display Port	2x DP
DVI	1x DVI-I
Multiple Display	Triple Display
VGA	Yes (by optional split cable)

### Storage

M.2	1x M.2 (M Key, NVMe PCIe x4, 2280) 1x M.2 (E Key, PCIe x2, USB 2.0, 2230, Support CNVi)
mSATA	1x mSATA (shared by 1x Mini PCIe)
SIM Socket	2x Internal SIM socket
SSD/HDD	2x Internal 2.5" SATA HDD Bay 2x Hotswap 2.5" SATA HDD Bay Support RAID 0, 1, 5, 10

### Expansion

Mini PCIe	2x Full-size Mini PCIe (1x Shared with mSATA)
PCI	1x PCI
PCIe	1x PCIe x16
Card Dimension	260 (L) x 129 (H) mm

### I/O

COM	2x RS-232/422/485, 4x RS-232/422/485 (Internal)
DIO	8 in / 8 out (Isolated)
LAN	2x RJ45
Universal I/O Bracket	2x Universal I/O Bracket (By mini PCIe interface)
USB	4x USB 3.2 Gen 2 (10 Gbps) 5x USB 3.2 Gen 1 (5Gbps, Internal) 2x USB 2.0 header (Internal)
Others	4x WiFi Antenna Holes 1x Power Switch, 1x AT/ATX Switch 1x Remote Power On/Off 1x PC/Car Mode Switch, 1x Delay Time Switch 1x Removable CMOS Battery

### Operating System

Windows	Windows 10
Linux	Linux kernel 5.X

### Power

Power Adapter	Optional AC/DC 24V/9.2A, 220W Optional AC/DC 24V/11.67A, 280W
Power Mode	AT, ATX
Power Supply Voltage	9 ~ 48 VDC

Power Connector	3-pin Terminal Block 4-pin 12V DC input as optional
Power Protection	Over-Voltage Protection (OVP) Over-Current Protection (OCP) Reverse Polarity Protection (RPP)

### Environment

Operating Temperature	-25°C to 70°C (35W CPU)
Storage Temperature	-30°C ~ 85°C
Relative Humidity	10% to 95% (non-condensing)
Certification	CE, FCC Class A, E-Mark, EMC Conformity with EN 50155, EN 50121-3-2
Vibration	3 Grms, 5 ~ 500 Hz, 0.5 hr/axis (SSD) 1 Grms, 5 ~ 500 Hz, 0.5 hr/axis (HDD)
Shock	20G, half-sine, 11 ms (SSD)

### Physical

Dimensions	137 (W) x 340 (D) x 240 (H) mm
Weights	8.9 kg
Construction	Extruded aluminum with heavy duty metal
Mounting Options	Wall Mount / Book Mount (Optional)

\* For 8th/9th CPUs configured to run at 65W, operating temperatures will be limited to 60°C.

\*\* 65W CPUS may experience thermal throttling depending on extreme application workloads; this is also due to an increase in the physical CPU cores from the Intel silicon (up to 8 cores). Please note, this does not indicate system malfunction or problems in the fanless design. Please consult our embedded engineers for the best configuration to match your application requirements.

\*\*\* All specifications and photos are subject to change without notice.

## External I/O Mechanical Layout

Front Panel

Rear Panel

Top Panel

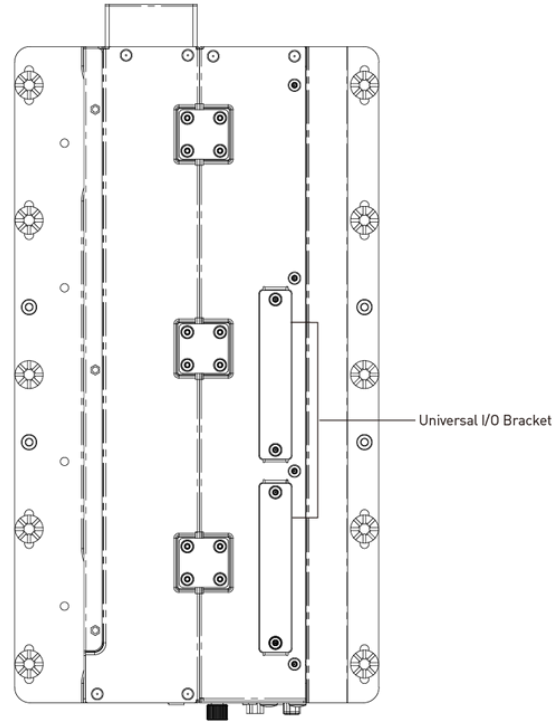
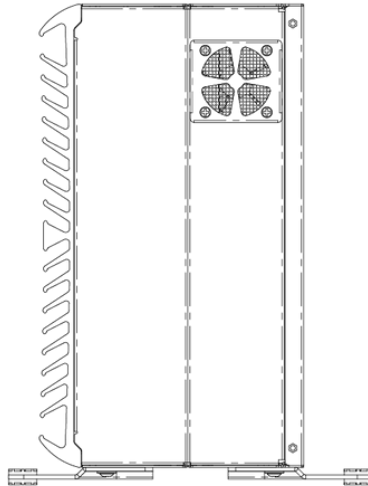
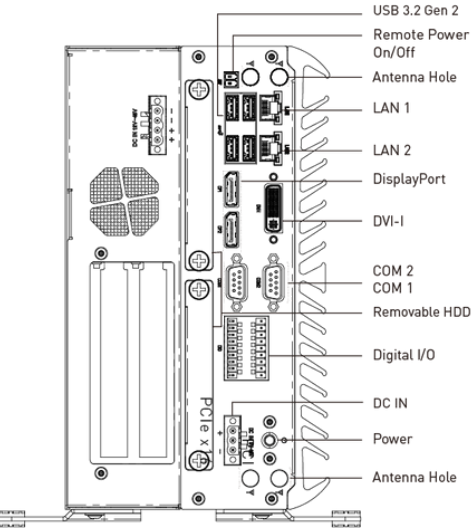

## Dimension

Unit: mm

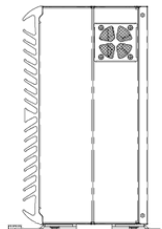
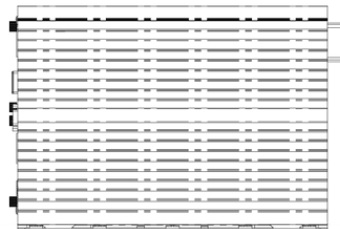
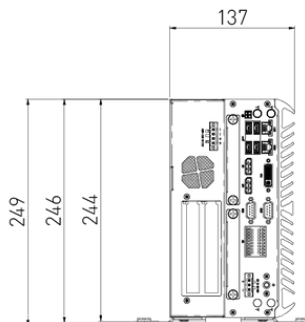
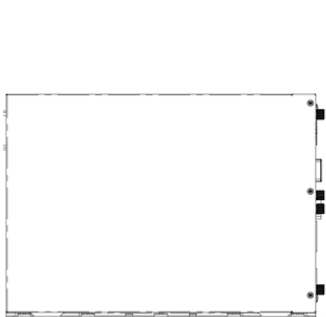
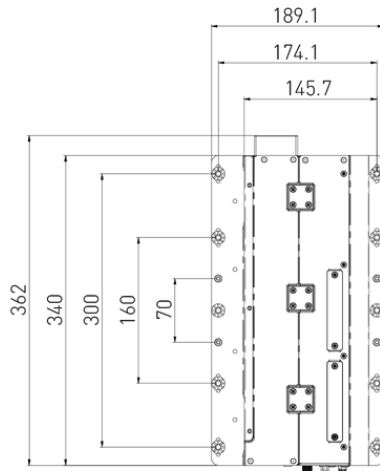

## Available Models

Model No.	Description
VCO-6000-CFL-2C-2PWR-P	Machine Vision Computer with 9th Gen Intel® Core™ CFL-R S Processor, 1x PCIe x16, 1x PCI Expansion, Dual Power Input

## Optional Accessories

Model No.	Description
1-E09A22801	Adapter AC/DC 24V/11.67A 280W with 3pin Terminal Block Plug 5.0mm Pitch
1-E09A22102	Adapter AC/DC 24V 9.2A 220W with 3pin Terminal Block Plug 5.0mm Pitch
999930	Power Cord, 3-pin US Type, 180cm
1-TPCD00002	Power Cord, European Type, 180cm
1-TPCD00001	Power Cord, 3-pin UK Type, 180cm

## Packing List

- 1x VCO-6000-CFL-2-2PWR Machine Vision Computer
- 1x Utility DVD Driver
- 1x Wall Mount Kit
- 1x Accessory Kit
- 1x DVI to VGA Adapter

## Compliances and Standards

Shock	20G, half-sine, 11 ms (SSD) IEC60068-2-27:2008 Designed to comply with MIL-STD-810G Method 516.7 Procedure I
Vibration	3 Grms, 5 ~ 500 Hz, 0.5 hr/axis (SSD) 1 Grms, 5 ~ 500 Hz, 0.5 hr/axis (HDD) IEC60068-2-64:2008 Designed to comply with MIL-STD-810G Method 514.7 Procedure I
Operating Temperature	-25°C to 70°C (35W CPU) IEC60068-2-1:2007 (Cold test procedure) IEC60068-2-2:2007 (Dry heat test procedure) IEC60068-2-3:2007 (Damp heat, steady state, test procedure) IEC60068-2-14:2009 (Wide temperature range thermal shock)
EMI	<ul style="list-style-type: none"> <li>• FCC Class A (47 CFR part 15.109 and part 15.107)</li> <li>• CE</li> <li>• ICES-003</li> <li>• UKCA</li> </ul>

## Exports And Tariff Codes

ECCN	5A992.c
HTS	8471.50.0150
ScheduleB	84.71